

Service
Service
Service

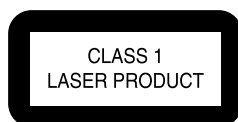

CL 16532007_000.eps
30-01-01

Service Manual



Contents

	Page
1 Technical specifications and connection facilities	2
2 Warnings, laser safety instructions and notes	3
3 Directions for use	6
4 Mechanical instructions and exploded views	16
5 Diagnostic software descriptions and troubleshooting	21
6 <i>Block- and wiring diagram</i>	
Blockdiagram	39
Wiring diagram	40
7 <i>Electrical diagrams and print-layouts</i>	<i>Diagram PWB</i>
Power supply	41 42-43
A/V Board Video control (Diagram A1)	44 46-47
A/V Board Audio (Diagram A2)	45 46-47
Display panel (Diagram D)	48 49
Bare board Standby	50 50
8 Electrical alignments	51
9 Circuit descriptions and List of abbreviations	51 54
10 Spare part list	55

RTV servis Horvat

Tel: ++385-31-856-637

Tel/fax: ++385-31-856-139

Mob: 098-788-319

www.rtv-horvat-dj.hr

© Copyright 2001 Philips Consumer Electronics B.V. Eindhoven, The Netherlands.
All rights reserved. No part of this publication may be reproduced, stored in a retrieval system or transmitted, in any form or by any means, electronic, mechanical, photocopying, or otherwise without the prior permission of Philips.



1. Technical specifications

Specification

PLAYBACK SYSTEM

DVD-Video
Video CD & SVCD
CD (CD-R and CD-RW)
DVD+RW
MP3 (DVD622 only)

OPTICAL READOUT SYSTEM

Lasertype Semiconductor AlGaAs
Numerical Aperture 0.60 (DVD)
0.45 (VCD/CD)
Wavelength 650 nm (DVD)
780 nm (VCD/CD)

DVD DISC FORMAT

Medium	Optical Disc	
Diameter	12cm (8cm)	
Playing time (12cm)	One layer	2.15 h*
	Dual layer	4 h*
	Two side	4.30 h*
	Single layer	
	Two side	8 h*
Dual layer		

VIDEO FORMAT

DA Converter 10 bits
Signal handling Components
Digital Compression MPEG2 for DVD,
MPEG1 for VCD

TV STANDARD

	(PAL/50Hz)	(NTSC/60Hz)
Number of lines	625	525
Playback	Multistandard	(PAL/NTSC)

DVD

Horiz. Resolution	720 pixels	720 pixels
Vertical Resolution	576 lines	480 lines

VCD

Horiz. Resolution	352 pixels	352 pixels
Vertical Resolution	288 lines	240 lines

VIDEO PERFORMANCE

Video output 1 Vpp into 75 ohm
RGB (SCART) output 0.7 Vpp into 75 ohm
Black Level Shift On/Off
Video Shift Left/Right

AUDIO FORMAT

Digital	MPEG	Compressed Digital
	DTS/Dolby Digital	16, 20, 24 bits
	PCM	fs, 44.1, 48, 96 kHz

Analog Sound Stereo
Dolby Pro Logic downmix from Dolby Digital multi-channel sound
3D Sound (TruSurround) for virtual 5.1 channel sound on 2 speakers

AUDIO PERFORMANCE

DA Converter	24 bits	
DVD	fs 96 kHz	4 Hz - 44 kHz
	fs 48 kHz	4 Hz - 22 kHz
	fs 44.1 kHz	4 Hz - 20 kHz
Video CD	fs 44.1 kHz	4 Hz - 20 kHz
CD	fs 44.1 kHz	4 Hz - 20 kHz
Signal-Noise (1kHz)		100 dB
Dynamic Range (1kHz)		97 dB
Crosstalk (1kHz)		110 dB
Distortion and Noise (1kHz)		88 dB
MPEG MP3		MPEG Audio L3

CONNECTIONS

SCART	Euroconnector
Video Output	Cinch (yellow)
Audio L+R output	Cinch (white/red)
Digital Output	1 coaxial
	IEC958 for CDDA / LPCM
	IEC1937 for MPEG1/2, Dolby Digital and DTS

CABINET

Dimensions (w x h x d)	435 x 81 x 295 mm
Weight	Approx. 3.5 Kg

GENERAL FUNCTIONALITY

Stop / Play / Pause
Fast Forward / Backward
Time Search
Step Forward / Backward
Slow Motion
Title / Chapter / Track Select
Skip Next / Previous
Repeat (Chapter / Title / All) or (Track / All)
A-B Repeat
Shuffle
Scan
New enhanced user graphical interface
Perfect Still with digital multi-tap filter
Zoom (x1.33, x2, x4) with picture enhancement
Smart Picture for convenient personal colour setting (DVD622 only)
PAL/NTSC Conversion (DVD622 only)
Screen Saver (Dim 75% after 15 min.)
3D Sound (TruSurround)
Virtual Jog Shuttle
Audio and video bit rate indicator

DVD FUNCTIONALITY

Multi-angle Selection
Audio Selection (1 out of max. 8 languages)
Subtitles Selection (1 out of max. 32 languages)
Aspect Ratio conversion (16:9, 4:3 Letterbox, 4:3 Pan Scan)
Parental Control and Disk Lock
Disc Menu support (Title Menu and Root Menu)
Resume (5 discs) after stop / standby
Programming Titles/chapters with Favourite Selection

VIDEO CD FUNCTIONALITY

Playback Control for VCD 2.0 discs
Disc Lock
Resume (5 discs) after stop / standby
Programming Tracks with Favourite Selection

AUDIO CD FUNCTIONALITY

Time Display (Total / Track / Remaining Track Time)
Full audio functionality with remote control
Programming with Favourite Track Selection

MP3 FUNCTIONALITY (DVD622 only)

Time Display (Track)
Album and Track Selection
Repeat (Disc / Album / Track)

* typical playing time for movie with 2 spoken languages and 3 subtitle languages.

Specifications subject to change without prior notice

2. Warnings and Laser safety instructions

GB WARNING

All ICs and many other semi-conductors are susceptible to electrostatic discharges (ESD). Careless handling during repair can reduce life drastically.
When repairing, make sure that you are connected with the same potential as the mass of the set via a wrist wrap with resistance.
Keep components and tools also at this potential.



NL WAARSCHUWING

Alle IC's en vele andere halfgeleiders zijn gevoelig voor elektrostatische ontladingen (ESD).
Onzorgvuldig behandelen tijdens reparatie kan de levensduur drastisch doen verminderen.
Zorg ervoor dat u tijdens reparatie via een polsband met weerstand verbonden bent met hetzelfde potentiaal als de massa van het apparaat.
Houd componenten en hulpmiddelen ook op hetzelfde potentiaal.

F ATTENTION

Tous les IC et beaucoup d'autres semi-conducteurs sont sensibles aux décharges statiques (ESD).
Leur longévité pourrait être considérablement écourtée par le fait qu'aucune précaution n'est prise à leur manipulation.
Lors de réparations, s'assurer de bien être relié au même potentiel que la masse de l'appareil et enfiler le bracelet serti d'une résistance de sécurité.
Veiller à ce que les composants ainsi que les outils que l'on utilise soient également à ce potentiel.

D WARNUNG

Alle IC und viele andere Halbleiter sind empfindlich gegen elektrostatische Entladungen (ESD).
Unvorsichtige Behandlung bei der Reparatur kann die Lebensdauer drastisch vermindern.
Sorgen sie dafür, das Sie im Reparaturfall über ein Pulsarmband mit Widerstand mit dem Massepotential des Gerätes verbunden sind.
Halten Sie Bauteile und Hilfsmittel ebenfalls auf diesem Potential.

I AVVERTIMENTO

Tutti IC e parecchi semi-conduttori sono sensibili alle scariche statiche (ESD).
La loro longevità potrebbe essere fortemente ridatta in caso di non osservazione della più grande cauzione alla loro manipolazione.
Durante le riparazioni occorre quindi essere collegato allo stesso potenziale che quello della massa dell'apparecchio tramite un braccialetto a resistenza.
Assicurarsi che i componenti e anche gli utensili con quali si lavora siano anche a questo potenziale.

GB

Safety regulations require that the set be restored to its original condition and that parts which are identical with those specified be used.

D

Bei jeder Reparatur sind die geltenden Sicherheitsvorschriften zu beachten.
Der Originalzustand des Gerats darf nicht verändert werden.
Für Reparaturen sind Original-Ersatzteile zu verwenden.

NL

Veiligheidsbepalingen vereisen, dat het apparaat in zijn oorspronkelijke toestand wordt terug gebracht en dat onderdelen, identiek aan de gespecificeerde worden toegepast.

I

Le norme di sicurezza esigono che l'apparecchio venga rimesso nelle condizioni originali e che siano utilizzati pezzi di ricambio identici a quelli specificati.

F

Les normes de sécurité exigent que l'appareil soit remis à l'état d'origine et que soient utilisées les pièces de rechange identiques à celles spécifiées.

SHOCK, FIRE HAZARD SERVICE TEST:

CAUTION: After servicing this appliance and prior to returning to customer, measure the resistance between either primary AC cord connector pins (with unit NOT connected to AC mains and its Power switch ON), and the face or Front Panel of product and controls and chassis bottom,
Any resistance measurement less than 1 Megohms should cause unit to be repaired or corrected before AC power is applied, and verified before return to user/customer.
Ref.UL Standard NO.1492.

NOTE ON SAFETY:

Symbol : Fire or electrical shock hazard. Only original parts should be used to replace any part with symbol
Any other component substitution (other than original type), may increase risk or fire or electrical shock hazard.

"Pour votre sécurité, ces documents doivent être utilisés par des spécialistes agréés, seuls habilités à réparer votre appareil en panne."

CL 96532065_002.eps
120799

LASER SAFETY

This unit employs a laser. Only a qualified service person should remove the cover or attempt to service this device, due to possible eye injury.

LASER DEVICE UNIT

Type:	SemiconductorlaserGaAIAs
Wave length:	650 nm (DVD) 780 nm (VCD/CD)
Output Power:	7 mW (DVD) 10 mW (VCD/CD)
Beam divergence:	60 degree



USE OF CONTROLS OR ADJUSTMENTS OR PERFORMANCE OF PROCEDURE OTHER THAN THOSE SPECIFIED HEREIN MAY RESULT IN HAZARDOUS RADIATION EXPOSURE.

AVOID DIRECT EXPOSURE TO BEAM

WARNING

The use of optical instruments with this product will increase eye hazard.
Repair handling should take place as much as possible with a disc loaded inside the player

WARNING LOCATION: INSIDE ON LASER COVERSIELD

CAUTION VISIBLE AND INVISIBLE LASER RADIATION WHEN OPEN AVOID EXPOSURE TO BEAM
ADVARSEL SYNLIG OG USYNLIG LASERSTRÅLING VED ÅBNING UNDGÅ UDSÆTTELSE FOR STRÅLING
ADVARSEL SYNLIG OG USYNLIG LASERSTRÅLING NÅR DEKSEL ÅPNES UNNGÅ EKSPONERING FOR STRÅLEN
WARNING SYNLIG OCH OSYNLIG LASERSTRÅLNING NÅR DENNA DEL ÄR ÖPPNAD BETRakta EJ STRÅLEN
VARO! AVATT AESSA OLET ALTTIINA NÄKYVÄLLE JA NÄKYMÄTT ÖMÄLLE LASER SÄTEILYLLE. ÄLÄ KAT SO SÄTEESEEN
VORSICHT SICHTBARE UND UNSICHTBARE LASERSTRAHLUNG WENN ABDECKUNG GEÖFFNET NICHT DEM STRAHL AUSSETSEN
DANGER VISIBLE AND INVISIBLE LASER RADIATION WHEN OPEN AVOID DIRECT EXPOSURE TO BEAM
ATTENTION RAYONNEMENT LASER VISIBLE ET INVISIBLE EN CAS D'OUVERTURE EXPOSITION DANGEREUSE AU FAISCEAU

Warning for powersupply on position 1005

The primary side of the powersupply including the heatsink carries live mains voltage when the player is connected to the mains even when the player is switched off !

This primary area is not shielded so it is possible to touch copper tracks and/or components when servicing the player. Service personnel have to take precautions to prevent touching this area or components in this area .

The primary side of the powersupply has been indicated with a lightning stroke and a stripe-marked printed on the printed wiring board

2.1 Notes

2.1.1 DVD-Module

For repair of the DVD-module ASD1, the service manual 3122 785 10840 has to be used.

2.1.2 Compair

For assistance with the repair process of the monoboard an electronic Fault finding guidance has been developed , this program is called COMPAIR.

This COMPAIR program is available on CDROM.

The Version of the CDROM for repair of the monoboard is V1.3 and can be ordered with codenumber : 4822 727 21637. This is an update CDROM , so when the COMPAIR CDROM is used for the first time , one has to install the COMPAIR ENGINE CDROM V1.2 first.

The V1.2 CDROM can be ordered with codenumber 4822 727 634 and has to registered after installation , the procedure for registration is explained in the help file of the program and in the booklet from the CDROM.

The cable to connect the monoboard with a PC can be ordered with codenumber 3122 785 90017.

All the hardware and software requirements of the systems necessary for working with COMPAIR is described on the CDROM.

4. Mechanical instructions

4.1 Dismantling instructions

www.itv-horvat-dj.hr

Cover 232
 -> Remove 7 screws 233
 -> Lift cover at rear side to remove

Mounting
 ↔
 Demounting

Front assy 200
 -> Unlock front from frame by releasing successively 4 snaps (2 each on the side bottom)
 -> Place front assy in front of the set (service position)

DVD module 218
 -> Remove connections to Mono-board
 -> Open Tray (See instruction below)
 -> Remove 4 screws 217 (module to frame)
 -> Demount module

AV board 1002
 -> Remove connections
 -> Remove 4 screws 227 (skt cinch and scart to back-plate)
 -> Release snaps of 2 spacers 221
 -> Demount board

Power supply unit 1005
 -> Remove connections
 -> Remove 2 screws 222 (board to frame)
 -> Release snaps of 2 spacer 221 (board to frame)
 -> Demount board

Display board 1003
 -> Remove 8 screws 211 (board to front)
 -> Demount board

Standby board and switch assy
 -> Remove 2 screws 211
 -> Demount board

DVD Mono board
 -> See also exploded view of DVD module
 -> Remove flex connections to turntable motor and sledge motor
 -> Remove 4 screws 10 to 13 (mono-board to VAL6011)
 -> Remove carefully flex connection to OPU and wire to the tray motor
 -> Demount the board

Manually opening of tray

When it is not possible to open the tray with the open/close button, the tray can manually be opened.

When no disc is loaded, unlock the tray by moving the slide from the left to the right and pull tray outwards.

When a disc is loaded, unlock the tray by pushing the slide inwards by way of a screwdriver and pull tray outwards.

Remove 4 screws to remove loader.

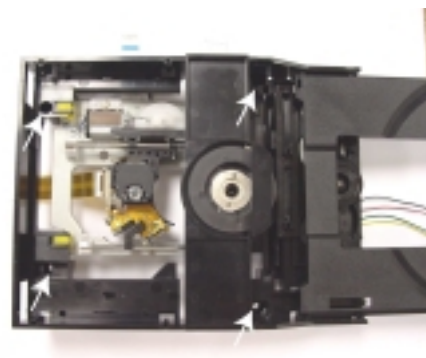
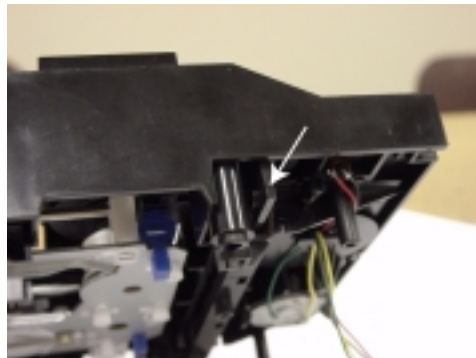
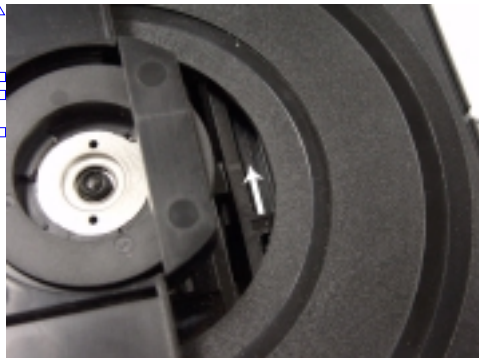

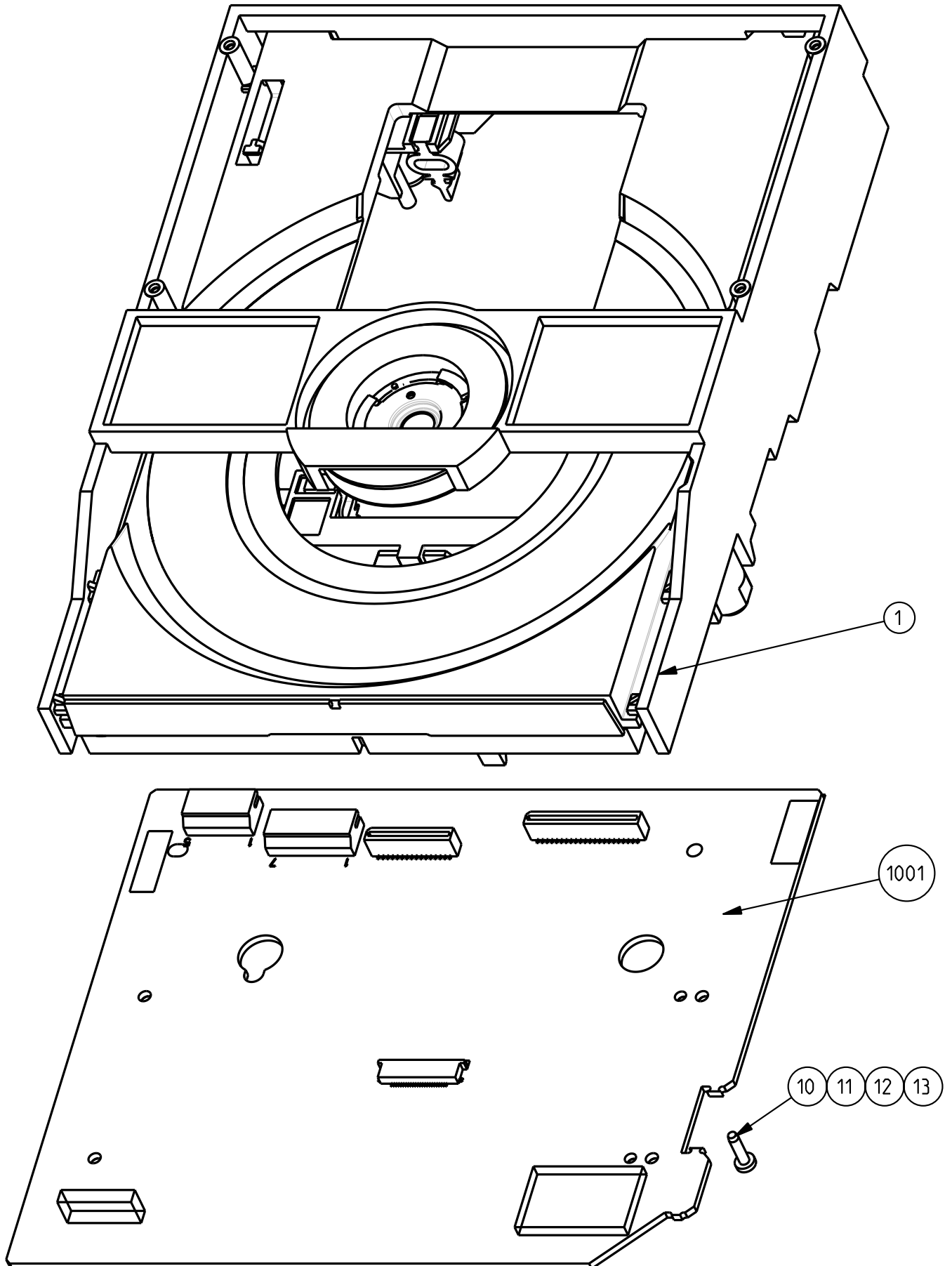

4.2 Exploded views

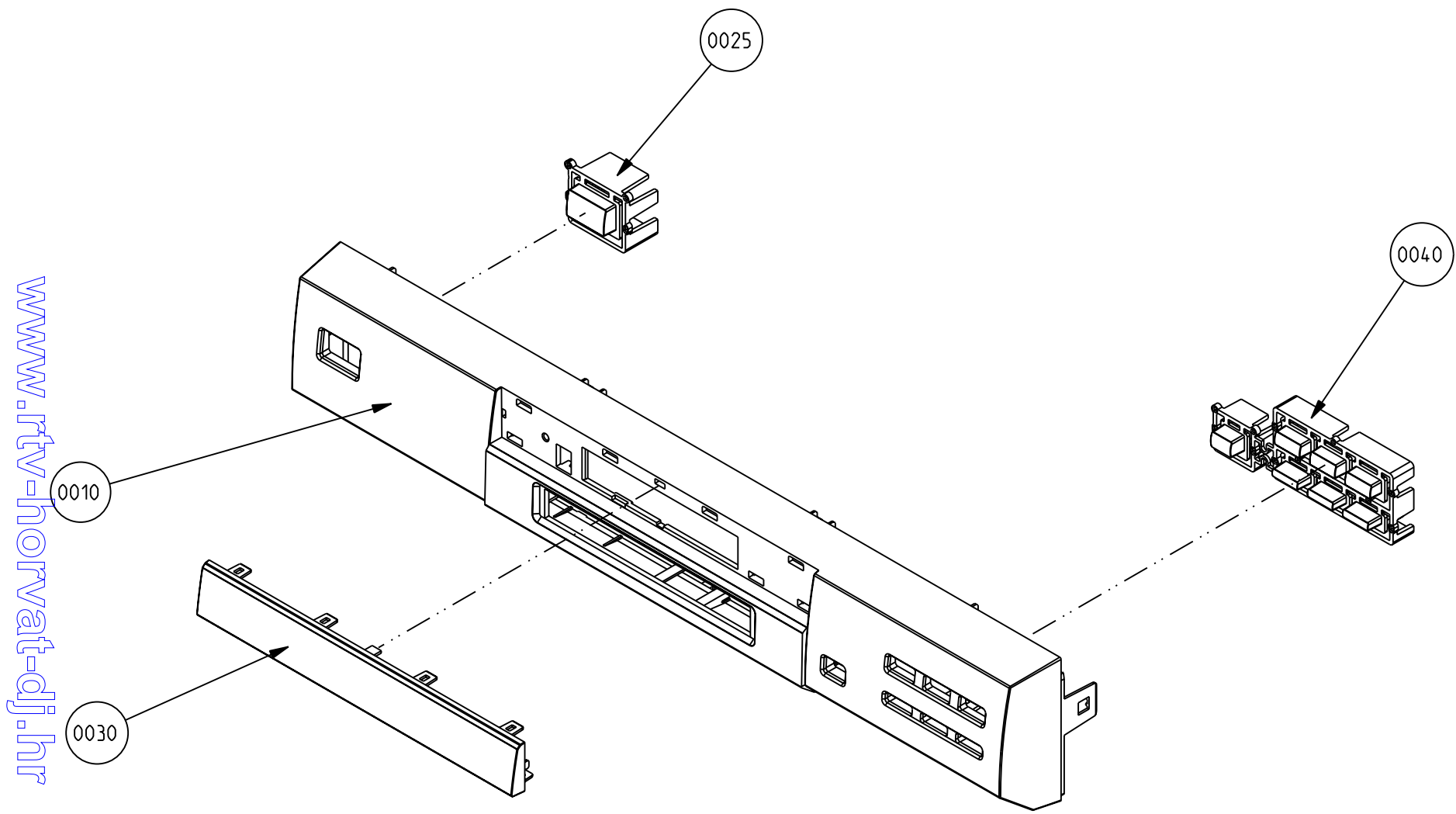

www.rtv-horvat-dj.hr

NUMBER IN CIRCLE CORRESPOND TO ITEM NUMBER IN P/L

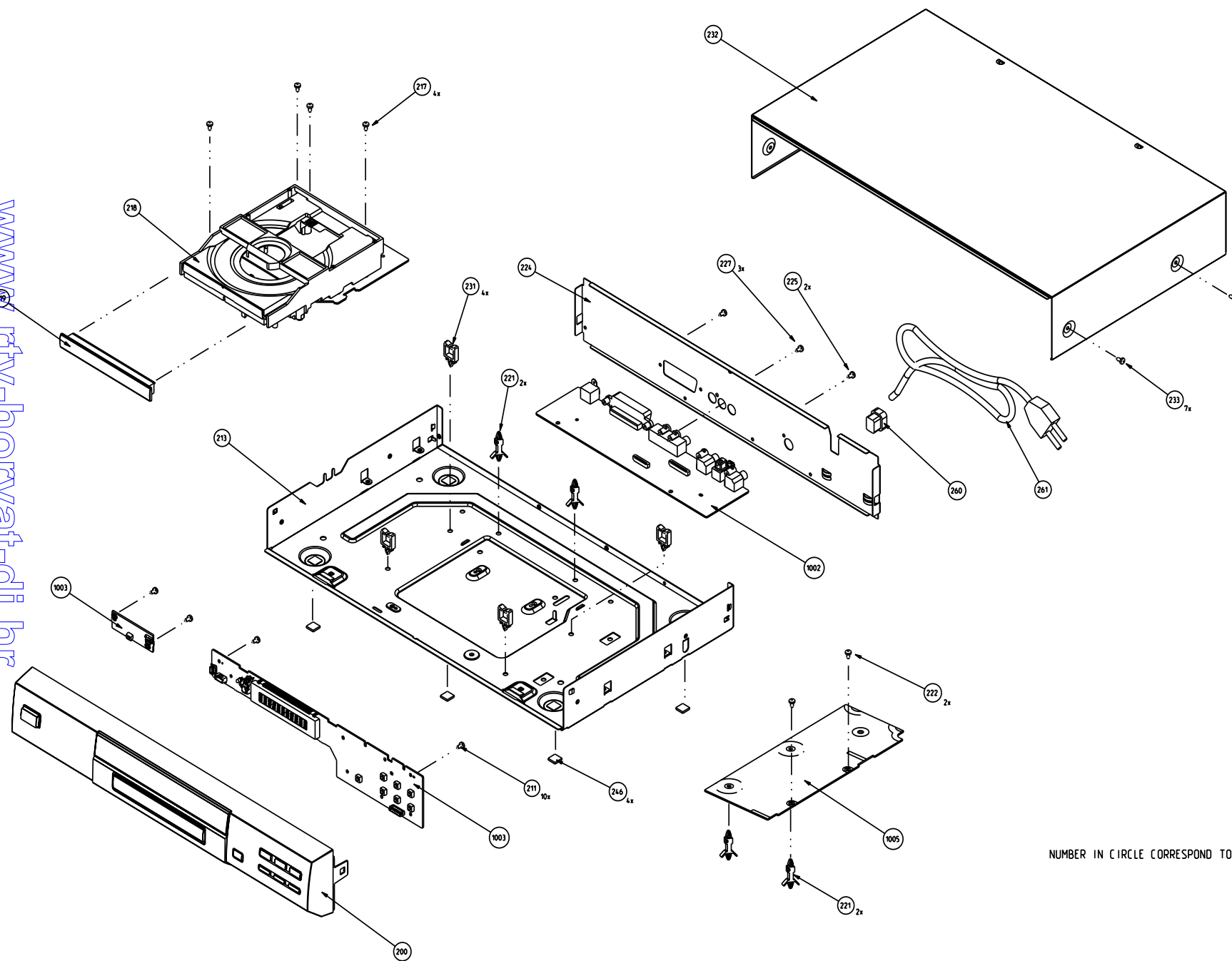

NUMBER IN CIRCLE CORRESPOND TO ITEM NUMBER IN P/L

4.3 Service position

See figure 4-1 for the service position

1. Remove the cables from the cable tie housing.
2. Remove 4 screws that mount the DVD module to the bottom frame.
3. Move the DVD module backward slightly and flip the module over, so that the component side of the board faces upwards, and the module is in the service position.

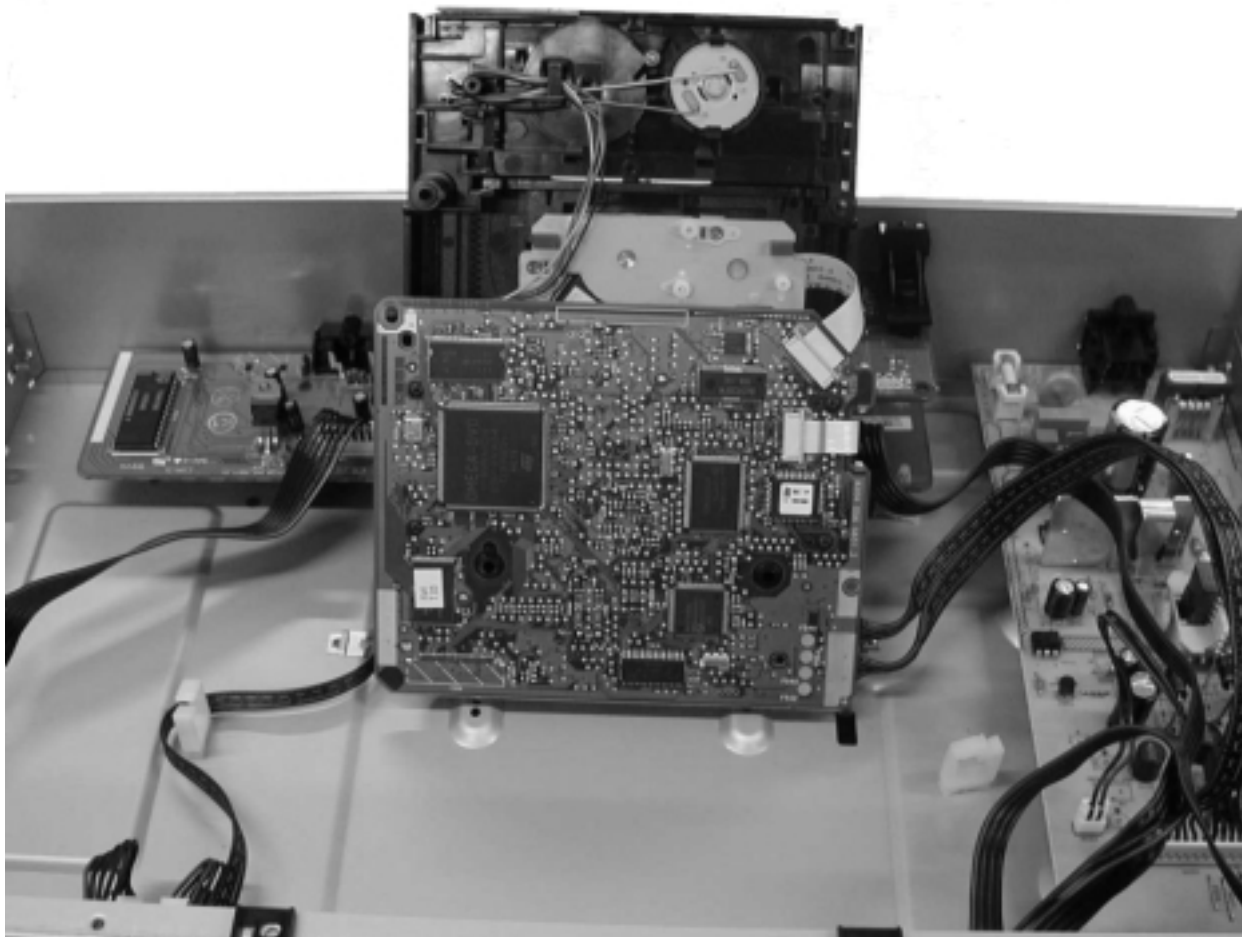

Figure 4-1

5. Diagnostic software descriptions and troubleshooting

5.1 Dealerscript

5.1.2 Contents of Dealer Script

5.1.1 Purpose of Dealer Script

The dealer script can give a diagnosis on a standalone DVD player; no other equipment is needed to perform a number of hardware tests to check if the DVD player is faulty. The diagnosis is simply a "error" or "pass" message; no indication is given of faulty hardware modules. Only tests within the scope of the diagnostic software will be executed hence only faults within this scope can be detected.

The dealer script executes all diagnostic nuclei that do not need any user interaction and are meaningful on a standalone DVD player.

The nuclei called in the dealer script are the following (the number after each nucleus name corresponds with the number being on the local display when the nucleus is executed during the dealer script):

Nucleus		Description
VideoColSetupComm	7	Checks the I2C interface with the RGB video processor on the Audio/Video board (only for DVD players with RGB video processor).
PapChksFl	6	Calculate and verify checksum of FLASH memory.
PapI2cDisp	5	Checks the I2C interface with the slave processor on the display PCB.
PapS2bEcho	4	Checks the I2C interface to the basic engine.
PapI2cNvram	3	Checks the I2C interface with the NVRAM.
PapNvramWrR	2	Pattern test of all locations in the NVRAM
CompSdramWrR	1	Pattern test of all locations in the SDRAM(s).

CL06532096_001.eps
050700

Figure 5-1

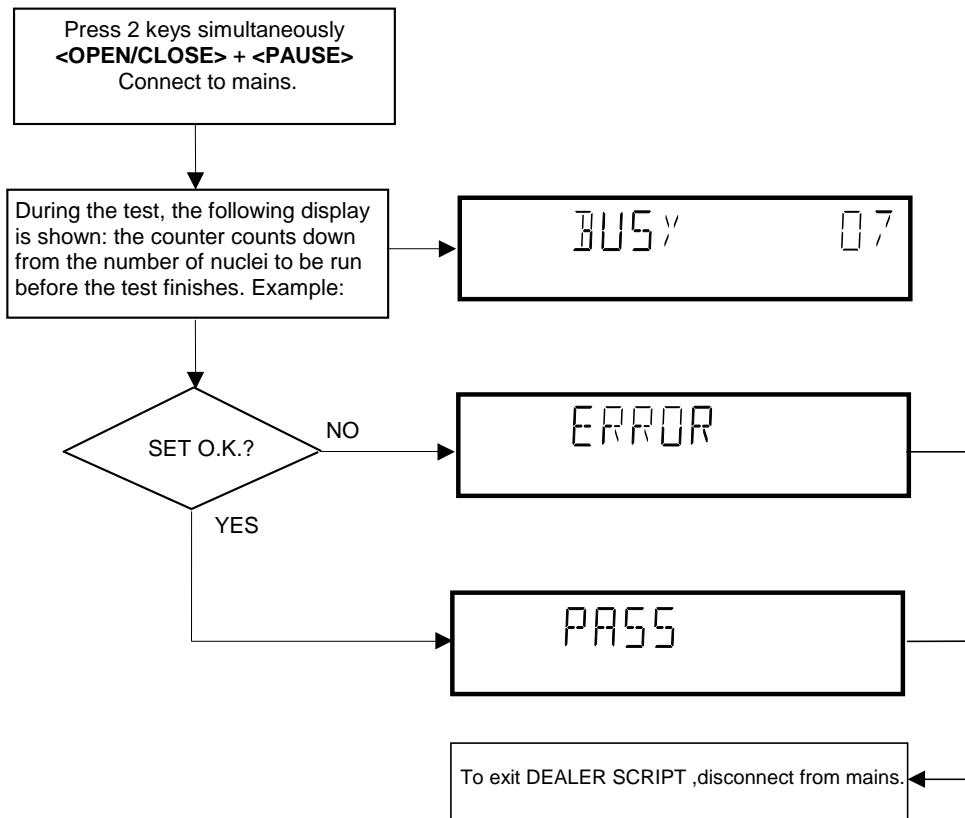

CL 96532065_004.eps
120799

Figure 5-2

5.2 PLAYER SCRIPT

5.2.1 Purpose of Player Script

The Player script will give the opportunity to perform a test that will determine which of the DVD player's modules are faulty, to read the error log and error bits and to perform an endurance loop test. To successfully perform the tests, the DVD player must be connected to a tv set to check the output of a number of nuclei. For DVDv2b a multi-channel amplifier, a set of 6 boxes and an external video source are necessary to test. To be able to check results of certain nuclei, the player script expects some interaction of the user (i.e. to approve a test picture or a test sound). Some nuclei (e.g. nuclei that test functionality of the Basic Engine module) require that the DVD player itself is opened, to enable the user to observe moving parts and approve their movement visually. Only tests within the scope of the diagnostic software will be executed hence only faults within this scope can be detected.

5.2.2 Contents of Player Script

The player script contains all nuclei that are useful on a DVD player that is connected to a tv-set and help to determine which module of the DVD player is faulty, as well as to read out the contents of the error logs.

5.2.3 Structure of Player Script

The player script consists of a set of nuclei testing the three hardware modules in the DVD player: the Display PWB, the Digital PWB and the Basic Engine.

Nuclei run by the player test need some user interaction; in the next paragraph this interaction is described. The player test is done in two phases:

1. Interactive tests: this part of the player test depends strongly on user interaction and input to determine nucleus results and to progress through the full test. Reading the error log and error bits information can be useful to determine any errors that occurred recently during normal operation of the DVD player.
2. The loop test will loop through the list of nuclei indefinitely, till the NEXT key is pressed. The list of nuclei is as follows:
 - VideoColSetupComm
 - VideoScartSwComm
 - PapChksFlash
 - PapI2cNvram
 - CompSdramWrR
 - PapS2bEcho
 - PapI2cDisp

For DSW version 1.6 and above. the DSW version number will be displayed on the local display. Press NEXT to continue to the display test.

The display should look like the following:

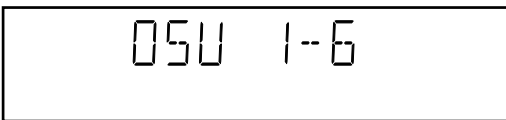
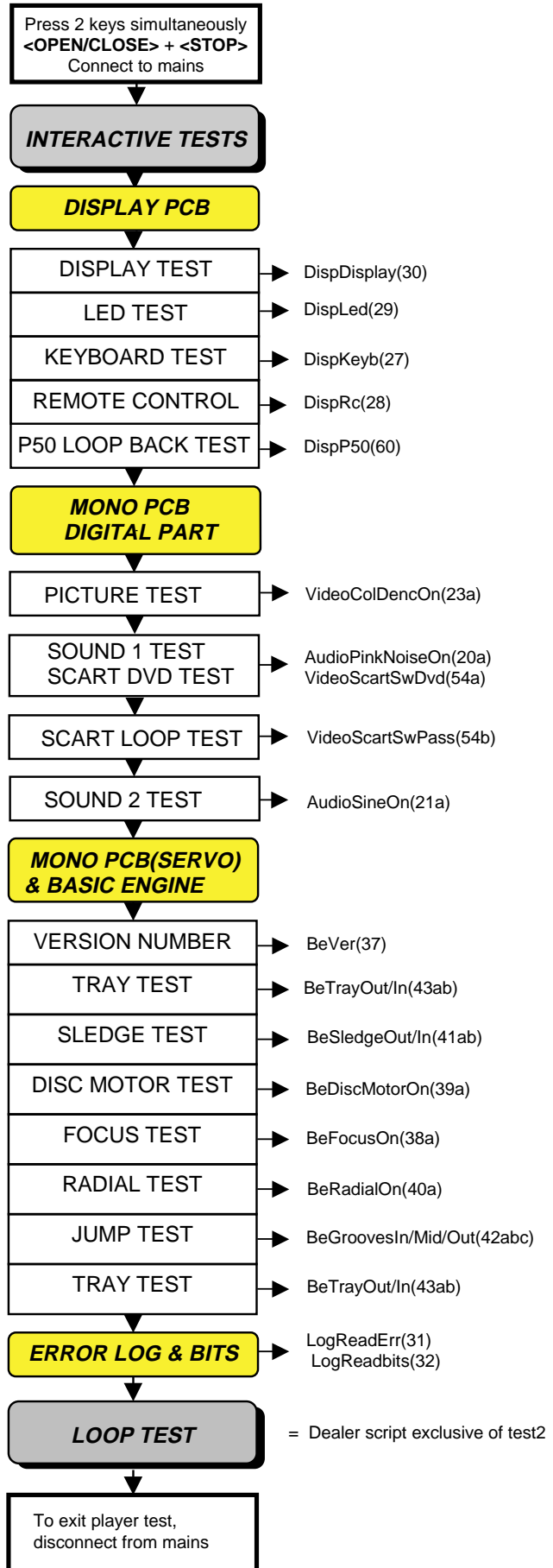

Figure 5-3

5.2.4 Survey



5.3 DISPLAY PCB

5.3.1 DISPLAY TEST

The display test is performed by nucleus DispDisplay. By putting a series of test patterns on the local display, the local display is tested. To step through all different patterns, the user must either press PLAY (pattern is ok) or PAUSE (pattern was incorrect) to proceed to the next pattern. The display of patterns is continued in a cyclic manner until the user presses NEXT. If the user presses NEXT before all display patterns are tested, the DispDisplay nucleus will return TRUE (display test successful).

5.3.2 LED TEST

The LED(s) on the DVD player is (are) tested by nucleus DispLed. The user must check if the LED(s) is (are) lighted; if it is, press PLAY, if it is not, press PAUSE. By pressing NEXT the script will proceed to the next test. If the user presses NEXT before PLAY or PAUSE, the DispLed nucleus will return TRUE (LED test successful).

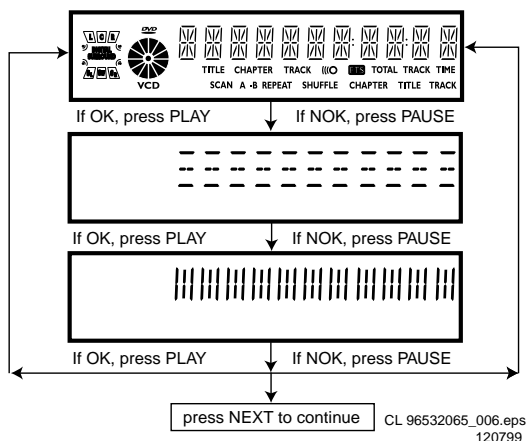

Figure 5-5

5.3.3 KEYBOARD TEST

The keyboard of the DVD player is tested by nucleus DispKeyb. The user is expected to press all keys on the local keyboard once. The code of the key pressed is shown on the local display (1 hexadecimal digit) immediately followed by a (hexadecimal) number indicating how many times that key has been pressed. Example of the local display during this test:

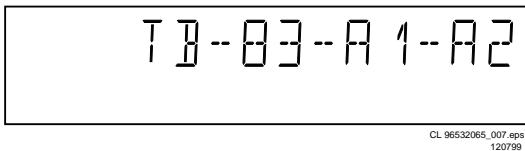

Figure 5-6

The key-codes displayed on the local display will scroll from right to left when the display gets full, the text "tb-" will remain on display.

key id.	key
0	PLAY
1	NEXT
2	PREVIOUS
3	PAUSE
4	STOP
5	OPEN/CLOSE
6	3D-SURROUND
7	KEY- (Mic Control)
8	Once More (Mic Control)
9	KEY+(Mic Control)
A	STAND BY

CL16532007_007.eps
300101

Figure 5-7

If any keys are detected more than once (due to hardware error), the key-code is displayed twice (or more), with the second digit increased by 1. If the user does not press all keys minimally once (in any order), the DispKeys nucleus will return FALSE and cause an error in the overall result of the player script. The test will also pass if all buttons, except the microphone key buttons, are pressed. The user can leave the keyboard test by pressing the NEXT key on the local display of the DVD player for at least one full second. The result of the keyboard test is shown on local display as follows:

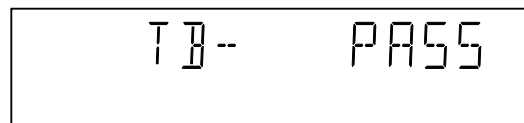

CL 96532065_009.eps
120799

Figure 5-8

Or

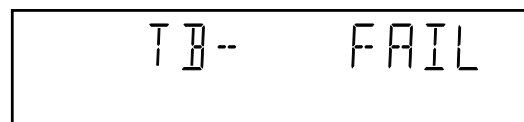

CL 96532065_010.eps
120799

Figure 5-9

Pressing NEXT on the local keyboard again will proceed to the next text.

5.3.4 REMOTE CONTROL TEST

The remote control of the DVD player is tested by nucleus DispRc. The user must press any key on the remote control just once. The codes of the key pressed will be shown on the local display in hexadecimal format. Example:

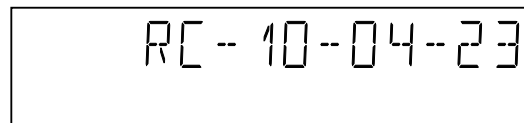

CL 96532065_011.eps
120799

Figure 5-10

In this example 23 is the hexadecimal code of the pressed RC key. The user can leave the remote-control test by pressing NEXT on the local keyboard of the DVD player. The remote

control test is successful if a code was received before the user pressed the NEXT key; pressing the NEXT key before pressing a key on the remote control gives an error in the remote control test (note that the remote control test will also fail if a key on the remote control was pressed but no code was received). The remote control test does not check upon the contents of the received code, that is it will not be checked if the received code matches the key pressed. If desired, the user can manually check this code by using a code-table for the remote control key-codes.

C Key id	Hexadecimal code
STANDBY	0C
STOP	31
PLAY	2C
PLAY BACKWARD	2D
PAUSE	30
STEP FORWARD	F6
STEP BACKWARD	F5
FORWARD	28
FORWARD 4X	DF
FORWARD 8X	E0
BACKWARD	29
BACKWARD 4X	DE
BACKWARD 8X	DD
SLOW	22
SLOW 2	D9
SLOW BACKWARD	23
SLOW BACKWARD 2	DA
NEXT	20
PREVIOUS	21
CURSOR UP	58
CURSOR DOWN	59
CURSOR LEFT	5A
CURSOR RIGHT	5B
OK	5C
0	0
1	1
2	2
3	3
4	4
5	5
6	6
7	7
8	8
9	9
TOGGLE	C8
ANGLE	85
AUDIO	4E
SUBTITLES	4B
SUBTITLE ON/OFF	E3
ROOT MENU	54
TITLE MENU	71
MENU	D1
SETUP MENU	82
OSD ON/OFF	F
RETURN	83
RESUME	D7
SCAN	2A
SHUFFLE	1C
REPEAT	1D
A/B REPEAT	3B
TOGGLE SCART	43
OPEN/CLOSE	42
FTS	FB
KARAOKE	E4
OPTION	FA

CL06532096_003.eps
050700

Figure 5-11

After pressing NEXT, the result of the remote control test is displayed on the local display of the DVD player as follows:

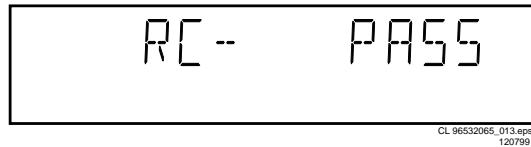

CL 96532065_013.eps
120799

Figure 5-12

Or

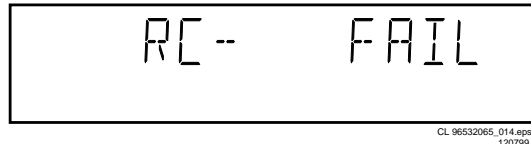

CL 96532065_014.eps
120799

Figure 5-13

Pressing NEXT on the local keyboard again will proceed to the next test.

5.3.5 P50 LOOP-BACK TEST

For the P50 loop-back test, the user must first press a key to decide if the test is to be performed.

The display will show the following message:

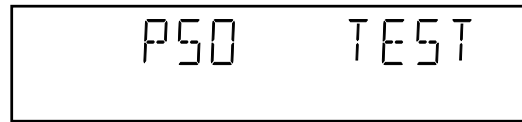

CL 16532007_004.eps
010201

Figure 5-14

If the user presses PAUSE, the P50 test will be skipped. If the user presses PLAY, the P50 test is performed and the result is displayed as follows:

Test successful:

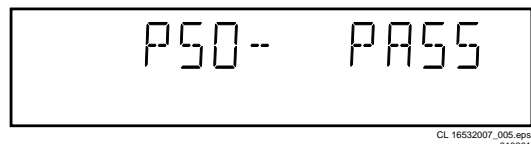

CL 16532007_005.eps
010201

Figure 5-15

Test fails:

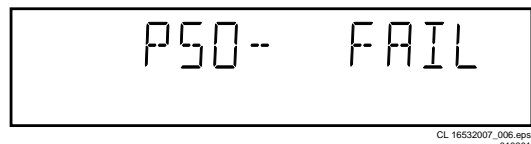

CL 16532007_006.eps
010201

Figure 5-16

Press the NEXT key to continue to the next text

5.4 MONO PCB DIGITAL PART

5.4.1 PICTURE TEST

The picture test is performed by putting a predefined picture (colour bar) on the display (nucleus VideoColDencOn) and

asking the user for confirmation. The display will show the following message:

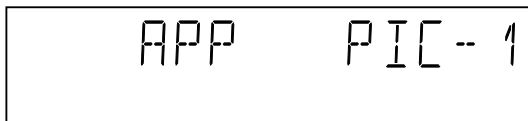

CL 96532065_015.eps
120799

Figure 5-17

By pressing PLAY the user confirms the test, pressing PAUSE will indicate the picture was invisible or incorrect. Pressing NEXT will proceed to the next test

5.4.2 SOUND 1 & SCART DVD TEST

The first soundtest is performed by starting a pink noise sound that needs confirmation from the user (nucleus AudioPinkNoiseOn); the display will show the following message very shortly:

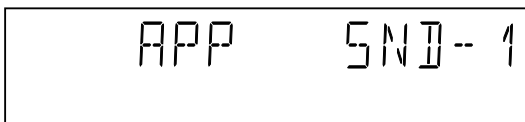

CL 96532065_016.eps
120799

Figure 5-18

This sound will only be audible from version cut3.1 of Sti5505(item7503 on mono board) onwards. After starting up sound 1, SCART loop-trough will be simultaneously active during this test. SCART loop-trough will be measured with the aid of an external video source.

When entering the SCART loop-trough, the local display indicates:



CL 96532065_017.eps
120799

Figure 5-19

On the TV screen a colour bar (generated by nucleus VideoColDencOn) is visual and the internally generated pinknoise is audible. By pressing PLAY the user confirms the test, pressing PAUSE will indicate the sound was inaudible or incorrect. Pressing NEXT will proceed to the next test; if the user presses NEXT without pressing PLAY or PAUSE first, the result of this test will be TRUE (sound ok). By pressing the NEXT button there will be switched over to the external source, this must become now visible on the TV screen (using the SCART). The local display indicates:



CL 96532065_018.eps
120799

Figure 5-20

The internally generated colour bar is still available on the CVBS and Y/C outputs. And the pinknoise-signal is still available on the cinch audio outputs. By pressing the PREV button, the internal generated colour bar becomes visual again.

The test can be left by pressing the NEXT key for more than one second.

5.4.3 SOUND 2 TEST

The second soundtest is performed by producing a sine sound (nucleus AudioSineOn). The signal can be stopped by pressing the STOP-key. The display will show the following message:

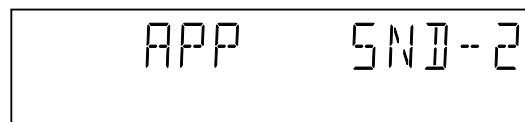

CL 96532065_019.eps
120799

Figure 5-21

By pressing PLAY the user confirms the test, pressing PAUSE will indicate that something went wrong. Pressing NEXT will proceed to the next; if the user presses NEXT without pressing PLAY or PAUSE first, the result of this test will be TRUE (sound ok).

5.4.4 Colour setup test

The colour setup test is performed by putting the internally generated colour bar in different settings on the TV screen. The first colour bar will be displayed in setting 1. the display will show the following message:

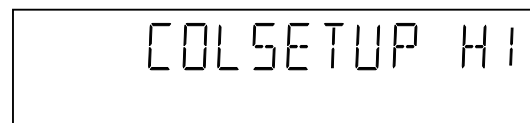

CL06532096_004.eps
050700

Figure 5-22

By pressing the NEXT button, you can go to the second setting. The local display indicates:

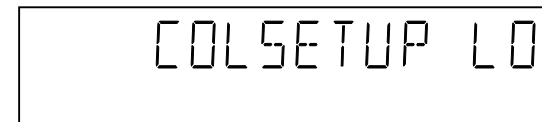

CL06532096_005.eps
050700

Figure 5-23

By pressing the PREVIOUS button, the colour bar with the first setting becomes visual again. By pressing PLAY the user confirms the test, pressing PAUSE will indicate that something went wrong. The test can be left by pressing the NEXT key for more than one second; if the user presses NEXT without pressing PLAY or PAUSE first, the result of the test will be TRUE (colour setup ok).

5.5 BASIC ENGINE

5.5.1 VERSION NUMBER

In the basic engine tests, the version number of the Basic Engine will be shown first, as the following example:

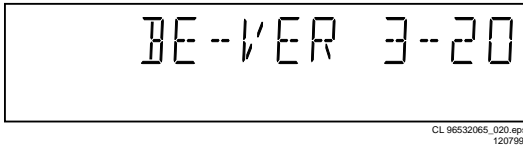

Figure 5-24

By pressing the NEXT key, the Basic Engine tests are started.

5.5.2 TRAY TEST

First, the tray is tested. The purpose of this test is also to give the user the opportunity to put a disc in the tray of the DVD player. Some tests on the Basic Engine require that a disc (e.g. DVD MPTD test disc) is present in the player. At the end of the Basic Engine tests this tray test will be repeated solely to enable the user to remove the disc in the tray. The local display will look as follows:

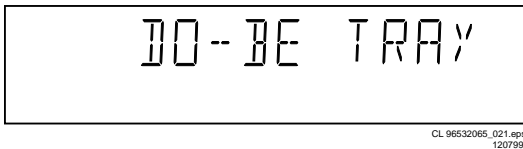

Figure 5-25

By pressing PLAY or PAUSE the user can toggle the position of the tray. Note that this test will not contribute to the test result of the Basic Engine. Pressing NEXT will proceed to the next test, after the tray has been closed (by the software) if it was open.

5.5.3 SLEDGE TEST(visual test)

The second Basic Engine test tests the sledge; the user can move the sledge as many times as desired by using PLAY (nucleus BeSledgeOut) and PAUSE (nucleus BeSledgeIn). Pressing NEXT on the local keyboard proceeds to the next test. Note that this test will not contribute to the test result of the Basic Engine. The local display will look as follows during the sledge test:

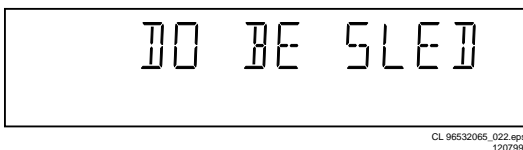

Figure 5-26

5.5.4 DISC MOTOR TEST(visual test)

The third Basic Engine test tests the disc motor (nucleus BeDiscMotorOn); the local display looks as follows:

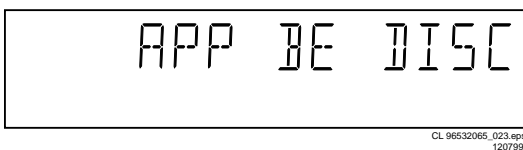

Figure 5-27

By pressing PLAY the user confirms that the disc motor is running; pressing PAUSE indicates the disc motor does not work. Pressing NEXT proceeds to the next test, after a reset

of the disc motor (nucleus BeDiscMotorOff). If the user presses NEXT before pressing PLAY or PAUSE, the result of this test will be TRUE (disc motor is running).

5.5.5 FOCUS TEST(visual test)

The fourth Basic Engine test tests the focussing; first focussing is turned on by calling nucleus BeFocusOn. The display will look as follows:

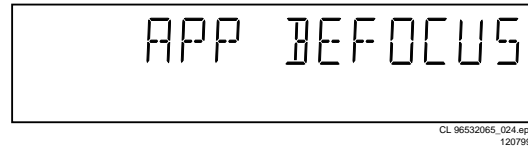

Figure 5-28

By pressing PLAY the user confirms that the focussing was successful; pressing PAUSE indicates a focussing failure. Pressing NEXT proceeds to the next test after a reset of the focussing (nucleus BeFocusOff); if NEXT is pressed before PLAY or PAUSE, the result of this test will be TRUE (focus successful).

5.5.6 RADIAL TEST(visual & listening test)

The fifth Basic Engine test tests the radial functionality (nucleus BeRadialOn); the local display looks as follows:

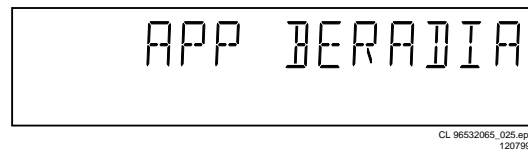

Figure 5-29

By pressing PLAY the user confirms that the radial function worked; pressing PAUSE indicates the function does not work. Pressing NEXT proceeds to the next test, after a reset of the radial (nucleus BeRadialOff). If the user presses NEXT before pressing PLAY or PAUSE, the result of this test will be TRUE (radial successful).

5.5.7 JUMP TEST(listening test)

The sixth and last Basic Engine test tests the jumping by calling nuclei BeGroovesIn, BeGroovesMid and BeGroovesOut. During this test, the local display looks as follows:

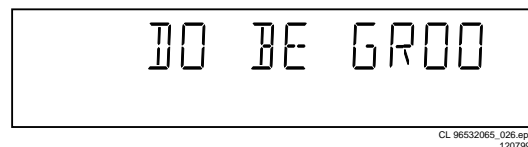

Figure 5-30

The user can switch between the three different types of groove settings by pressing PLAY (forward to next nucleus in the list In-Mid-Out) or PAUSE (backward in the list In-Mid-Out). This is done in a cyclic manner; note that this test will not contribute to the test result of the Basic Engine. Pressing NEXT proceeds to the next test, after the disc motor has been shut off with a call to nucleus BeDiscMotorOff.

5.5.8 TRAY TEST

As a last action for the Basic Engine tests, the tray test is repeated. The local display will look as follows:

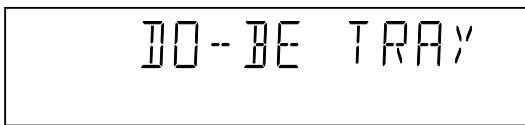

Figure 5-31

This test is meant to give the user the opportunity to remove the disc in the tray. The tray position can be toggled using the PLAY and PAUSE key. The tray will be closed (by the software, if it is open) before proceeding to the next test when the user presses the NEXT key.

5.5.9 ERROR LOG (see table on page 30)

Reading the error log and error bits information can be useful to determine any errors that occurred recently during normal operation of the DVD player. Reading the error log is done by nucleus LogReadErr. The display during the errorlog readout looks as follows :

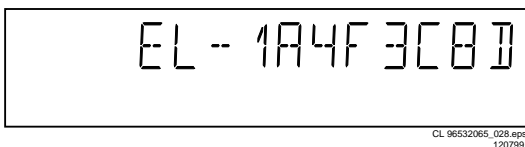

Figure 5-32

By pressing PLAY or PAUSE the user can move forward or backward (respectively) through the logged error codes. The highlighted number indicates which errorcode is currently on display (in the example above, errorcode number 4 is displayed). If "0000" is displayed at all positions, the error log is empty. Display of the logged errors is done in a cyclic manner. The errorcode with the lowest highlighted number is the most recent. By pressing NEXT on the local keyboard, the user can proceed to the next test.

5.5.10 ERROR BITS (see table on page 30)

Reading the error bits is done by nucleus LogReadBits. The display during the errorbits readout looks as follows:

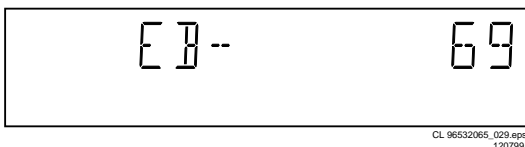

Figure 5-33

Only the set errorbits will be shown by their (decimal) number. Refer to the appropriate documentation for the explanation of each bit number. If the display only shows "EB-0", no error bits were set. By pressing NEXT the user can continue to the next test.

5.6 LOOP TEST (see table below)

At the start of the loop test, the display will show the result of the interactive player test:

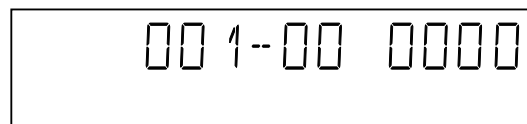

Figure 5-34

The left side of the display contains a 3-digit code, which can have a value between 000 and 111. These values are to be interpreted as follows:

Displayed Value	Indication for each module		
	Basic Engine	Mono PCB	Display PCB
000	ok	ok	ok
001	ok	ok	faulty
010	ok	faulty	ok
011	ok	faulty	faulty
100	faulty	ok	ok
101	faulty	ok	faulty
110	faulty	faulty	ok
111	faulty	faulty	faulty

CL 96532065_031.eps
120799

Figure 5-35

The loop test will perform the same nuclei as the dealer test, but it will loop through the list of nuclei indefinitely. The display of the DVD player will display not only the three digits indicating correct/faulty modules and the last found error code (as mentioned, faults are detected as far as they can be within the scope of the diagnostic software), but also a loop counter indicating how many times the loop has been gone through. Example:

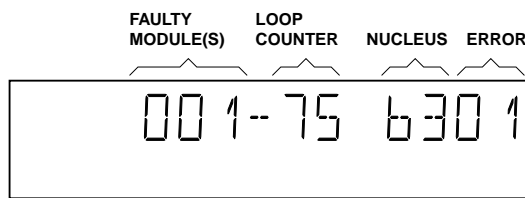

Figure 5-36

The number after the hyphen indicates the number of times the loop test has been performed; the 4 digits at the right side of the display show the last error that was found when running the loop test: the leftmost two digits of this code indicate which nucleus resulted in a fault; the rightmost two digits refer to the faultcode within that nucleus. For further explanation of this error code, see list of error codes below.

ERROR CODES LOOP TEST

ERROR CODE	NUCLEUS NUMBER	ERROR DESCRIPTION
0601	6	Calculated checksum of FLASH is not correct
1101	11	I2C bus busy before start
1102		NVRAM access time-out
1103		No NVRAM Acknowledge
1104		NVRAM reply time-out
1201	12	I2C bus busy
1202		I2C bus not working
1203		Slave controller not responding
1204		Slave response is not correct
1301	13	Parity error from basic engine to serial
1302		Parity error from serial to basic engine
1303		No communication between serial and basic engine
1304		Communication time-out error
1601	16	The SDRAM is faulty
5201	52	I2C bus busy
5202		Error sending I2C command to COLOR SETUP IC
5203		Colour setup IC not responding
5204		Colour setup IC response is not correct
5401	54	I2C bus busy
5402		Error sending I2C command to SCART SWITCH IC
5403		SCART Switch is not responding
5403		SCART Switch response is not correct

CL06532096_006.eps
050700

Figure 5-37

Error log / bits table	Read ERROR LOG in player script	Read ERROR BITS in player script
Basic engine errors	Value:	Value:
Command to the Basic Engine not allowed in this state or unknown command	150101	8
Parameter(s) from the command to the Basic Engine is not valid	150102	7
Sledge could not be moved to the inner home position	150103	6
Focus failure	150104	5
Turntable motor speed could not be reached within timeout	150105	4
Radial servo could not get on track on the disc	150106	3
PLL could not lock in the accessing or tracking state	150107	2
Subcode or sector information could not be read	150108	1
requested subcode could not be found	150109	16
Tray could not be closed or opened completely	15010A	15
TOC could not be read within timeout	15010B	14
The requested seek on the disc could not be executed	15010C	13
A requested lead-in is not on the disc	15010D	12
A non existing burst cutting area is requested	15010E	11
S2b communication error	1501F0	10
S2b communication error	1501F1	9
S2b communication error	1501F3	24
S2b communication error	1501F4	23
S2b communication error	1501F5	22
Digital PWB errors		
Communication error with the Sti 5505	90000	32
Communication error with the Sti 5505	90001	31
Display processor errors		
Communication error with the display processor	190000	40

5.6.1 Servicing DVD loader

The DVD Loader / mechanism, VAL6011, has to be exchanged completely in case of failure. A new mechanism can be ordered with codenumber 9305 023 61101.

5.6.2 Reprogramming of new mono boards.

Caution

This information is confidential and may not be distributed. Only a qualified service person should reprogram the mono board.

After reset of NV-memory or repair of the mono board, all the customer settings and also the region code will be lost.

Reprogramming of the mono board will put the player back in the state in which it has left the factory, i.e. with the default settings and the allowed region code.

Reprogramming is limited to 25 times

When the counter reaches 25, reprogramming is not possible anymore

Reprogramming will be done by way of the remote control.

Put the player in stop mode, no disc loaded.

Press the following keys on the remote control:
 <PLAY> followed by numerical keys <1> <5> <9>

The display shows: "-----"

Press now successively the following keys :

for DVD612 /002 /021 /051 : <0><2><7> <0><0><0><0><0><0><0><0><0>

Press <PLAY> again.

The TV screen will become BLUE during a short time to confirm that the mono board has been reprogrammed, then the set goes to standby mode.

CL 16532007_008.eps
010201

Figure 5-38

5.6.3 Reset of Virgin Mode

After the player has been powered up for test by the dealer, it would have gone through the Virgin Mode. It is possible to reset the settings made during that mode before the delivery of player to the customer. This can be done as shown in the following diagram:

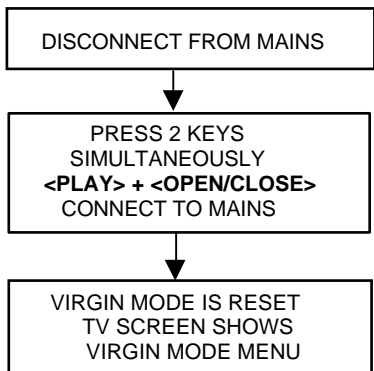

CL 96532065_034.eps
070700

Figure 5-39

TRADE MODE

When the player is in Trade Mode, the player cannot be controlled by means of the front key buttons, but only by means of the remote control.

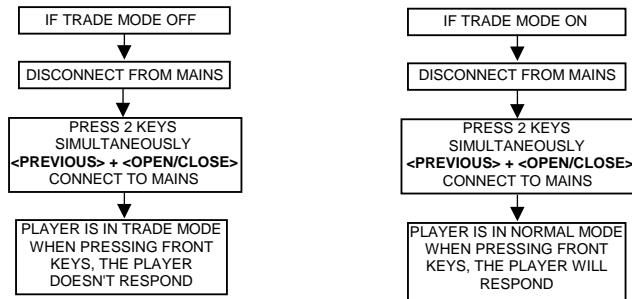

C06532096_008.eps
050700

Figure 5-40

5.7 Test Instruction Audio/Video Board

These test instructions can be used for all versions of the A/V board which has the following outputs:

- Audio L/R
- 5.1 Audio output
- Subwoofer output
- Optical / Coaxial digital output
- CVBS
- Y/G_vid,U/B_vid,V/R_vid output
- S-video
- Scart output

5.7.1 General

- All the waveforms measurement carried out in these test instruction will be base on the testpoint indicated in the A/V board schematic diagram in the Service manual.
- Impedance of the measuring-equipment should be > 1M Ω
- Most of the tests can be done using either the Diagnostic software " Player script" which can be found in the chapter "Diagnostic Software description and troubleshooting" or the Menu interface using the Service PC with a terminal emulation program (e.g. Window Hyperterminal) where it is possible to control the execution of the Diagnostic Nuclei
- Setup for the measurement will be done in set level with all modules connected as shown in the Wiring Block diagram.

5.7.2 General start-up measurement

Supply check:

Before starting the measurement,ensure that all power supply are connected to the A/V board.

Pin nbr	Supply
1010-9	-5V (-Vcc)
1010-10	+5V
1010-11	+5V

The supply currents can be measured using a Tektronics AM503B current probe or equivalent.

Supply	Power consumption (AVG)
+5VA	+5V \pm 3% I = 200mA
+5Vvid	+5V \pm 3% I = 200mA
-5V	-5V \pm 3% I = 200mA

Clock Check

Ensure the present of the clock to the DAC

Clock Name	Testpoint	Frequency
PCM_CLK	TP10	11.2896MHz \pm 0.02% tolerance

Audio mute check

Measure the Audio mute voltage input at pin 12 of connector 1010

Status	Value
AudioMuteOn	4.7V \pm 10%
AudioMuteOff	-8V \pm 10%

To toggle between ON and OFF,use the following commands:

Ref.#	Command Name	Remarks
19a	AudioMuteOn	Audio Mute On
19b	AudioMuteOff	Audio Mute Off

5.7.3 Audio DAC and amplifier

Ensure that the Audio mute signal is OFF

To check the DAC and buffer amplifier,send the following commands:

Ref.#	Command Name	Remarks	Audio output
21a	AudioSineOn	Audio Sine signal ON	Sine,1Khz on stereo
----	Press stop button	Audio Sine signal OFF	No waveform
20a	AudioPinkNoiseOn	Audio Pinknoise ON	Pink Noise on 6 channels
20b	AudioPinkNoiseOff	Audio Pinknoise OFF	No waveform

The audio signal (sine or pink noise) will also be present on the digital output (SPDIF).This can be checked by connecting digital signal to an amplifier with digital input. Check the I2S and audio signal at the following testpoints:

Name	Testpoint
LRCLK	TP8
SCLK	TP9
PCM_CLK	P10
PCM_OUT0	TP7
PCM_OUT1	TP27
PCM_OUT2	TP28
SPDIF	TP11
Front L/R out-Audio cinch	TP13
H/P L/R out	TP20
Analog out -Audio cinch	TP25

All waveforms can be refer to the waveform diagram in the chapter "Diagnostic software description and troubleshooting".

5.7.4 Video output and buffer amplifier

Check DC output-level at all video cinch output : 1.0V DC \pm 10%

Generate a color bar using the following software commands:

Ref.#	Command Name	Remarks
23a	VideoColDencOn	Colour DENC ON
61a	VideoColOutRGB	RGB Colourbar
61b	VideoColOutYUV	YUV Colourbar
23b	VideoColDencOff	Colourbar DENC OFF

Check the video outputs at the following testpoints:

Name	Testpoint
B_VID	TP1
G_VID	TP2
R_VID	TP3
CVBS out	TP14
S-Video-C out	TP15
S-Video-Y out	TP16
Y out	TP17
U out	TP18
V out	TP19

All waveforms can be refer to the waveform diagram in the chapter "Diagnostic Software description and troubleshooting".

5.7.5 Play and 16/9 detection

Check DC voltage at S-Video-chroma output (pin 4) with a 6K8 ohm load and Scart connector (pin 8) and change the 0/6/12 input (1010-8) using the following commands:

Ref.#	Command Name	Remarks	Chroma output
25a	VideoScartLo	Sends out 0V ± 0.5V	<0.1V
25b	VideoScartMi	Sends out 6V ± 10%	2.0V ± 10% with load 5.0V ± 10% without load
25c	VideoScartHi	Sends out 12V ± 10%	<0.1V

5.7.6 Kill circuit

To check the functionality of the Kill circuitry, the audio outputs has to be present by the following command:

Ref.#	Command Name	Remarks	Audio output
21a	AudioPinkNoiseOn	Audio Pinknoise ON	Pink Noise on 6 channels

Check the audio outputs at the audio cinch of the A/V board : Pink Noise

Activate the Kill circuit by using the following command:

Ref.#	Command Name	Remarks
19a	AudioMuteOn	Audio Mute On

Check the audio outputs at the audio cinch of the A/V board : No waveform

Switch off the kill circuit by using the following command:

Ref.#	Command Name	Remarks
19b	AudioMuteOff	Audio Mute Off

Check the audio outputs at the audio cinch of the A/V board : Pink Noise

5.8.2 Functionality description:

The essential component of the display PCB is the μ P (slave). This slave works on an 8MHz resonator and has a reset circuit that is triggered by the +5Vstby. After the reset pulse, the standby control line will release the reset of the host μ P. This host μ P will then initialise the slave. In addition, when going to stand-by, the slave will put the host μ P in reset. When the slave receives the right IR or key code to leave the standby mode, the reset of the host μ P will be released. Other slave functions are:

- Square signal generator to generate the filament voltage, which is required for an AC FTD.
- Generates the grid and segment scanning for the FTD.
- Generates a scanning grid for the keys (separated from display scanning).
- Has inputs for RC (RC5 and RC6) and P50 (P50 controller is built in).

5.8.3 General

- Oscilloscope measurements have been carried out using a Philips PM3392A.
- Impedance of measuring-equipment should be > 1M Ω .
- To do correct measurements we recommend to use supply 3122 427 22570.

5.8 Test instructions Display board

5.8.1 Introduction

These test instructions are written for all versions of the display PCBAS. The contents of the PCB can be split up into next blocks:

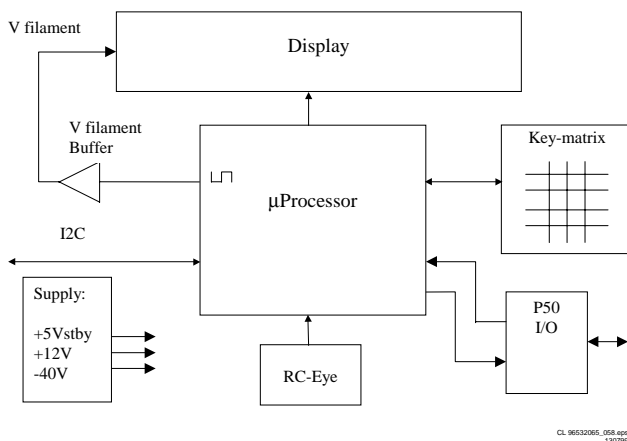

Figure 5-41

5.8.4 Reset

Check next reset timing with an oscilloscope at pin 10 of the microprocessor.

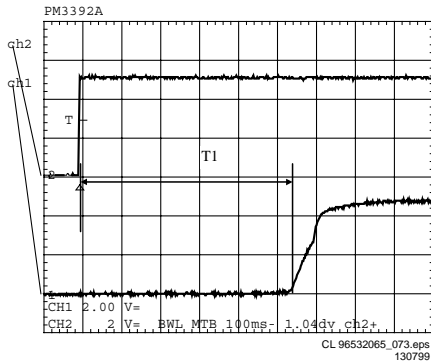

Figure 5-42

Timing: 400msec < T1 > 700msec.
 CH1: +5Vstby voltage at power on.
 CH2: Voltage at pin 10.

5.8.5 Display steering

Check next timing and level for all grid-lines (G1 r G14).

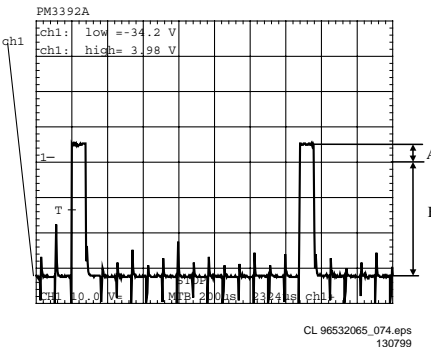

Figure 5-43

1. Check level A: +4V5 +/-10% for grid lines 1 => 11
2. Check level A: +4V0 +/-10% for grid lines 12 => 14
3. Check level B: -33V +/-10%
4. Check timing and levels of segment-lines P1 => P10:

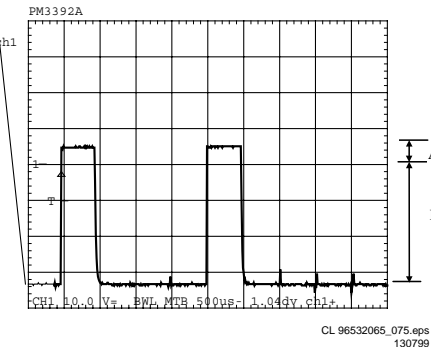

Figure 5-44

Level A: +4V5 +/-10%
 Level B: -33V +/-10%

The data on these segment-lines depend on the characters that are displayed.
 The characters can be set by sending I2C commands to the display.

See the Slave URS how to send a display command.

5.8.6 Key-matrix

Connect an extra 10kΩ pull-up to pin 36 en 37 of the μP and check next matrix scanning at these pins.

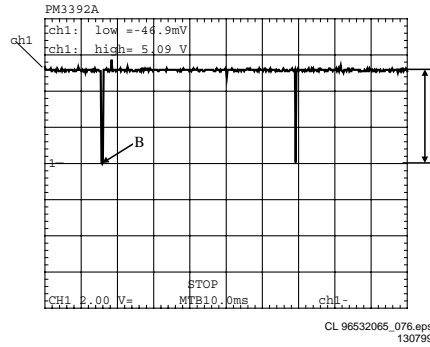

Figure 5-45

Level A: 5.0V +/-7%
 Level B: 0V +/-200mV
 Check matrix scanning from pin 26 until 33 of the μP.
 The results should be the same as the diagram above.

5.8.7 I.R. receiver

Check at pin 23 of the μP if this line switches from low (< 0.3V) to high (> 4.5V), while pressing a key on a Philips RC5 or RC6 remote control.

5.8.8 Karaoke interface

The karaoke interface (4 lines) is a single direction communication.
 This means that it consists of four μP output lines.
 The interface can be checked by setting or resetting these output-ports via the I2C bus.
 Send next command via the I2C bus:

Address	: 0x70
Command byte	: 0x24
Data byte	: xxxabcd
Where	: a = Karaoke reset.
	: b = Karaoke data.
	: c = Karaoke clock.
	: d = Karaoke strobe.

5.8.9 P50 interface

P50 is a bi-directional serial interface, which is used for communication between video equipment. For European sets, this communication goes via pin 10 of the scart-bus. In other regions, it can be a cinch bus at the back of the set.

1. Keep the μP in reset by short-circuiting emitter and collector of transistor 7108, via resistor 3100 and 3104 transistor 7101 is switched on.
2. Check the voltage at the P50 output connector 1118-5: < 200mV.

When the reset is released the μP output-pin becomes low and transistor 7101 is switched off.

1. Check the voltage at the P50 output connector 1118-5: 4V9 +/-5%.
2. Check also the μP P50 input (μP pin 20): 5V +/-5%.
3. Connect the P50 line (connector 1118-5) to ground.
4. Check again the μP P50 input (μP pin 20): <0V3.

5.9 Troubleshooting

5.9.1 Troubleshooting A/V board

Testing of A/V board can be done using diagnostic software "PLAYER SCRIPT".

MONO board is used to generate a sound with the sound tests SND-1 and SND-2 or a VIDEO signal with the picture "DIAGNOSTIC SOFTWARE: SCRIPT INTERFACES".

AUDIO PART OF AUDIO/VIDEO BOARD 3139 243 30241

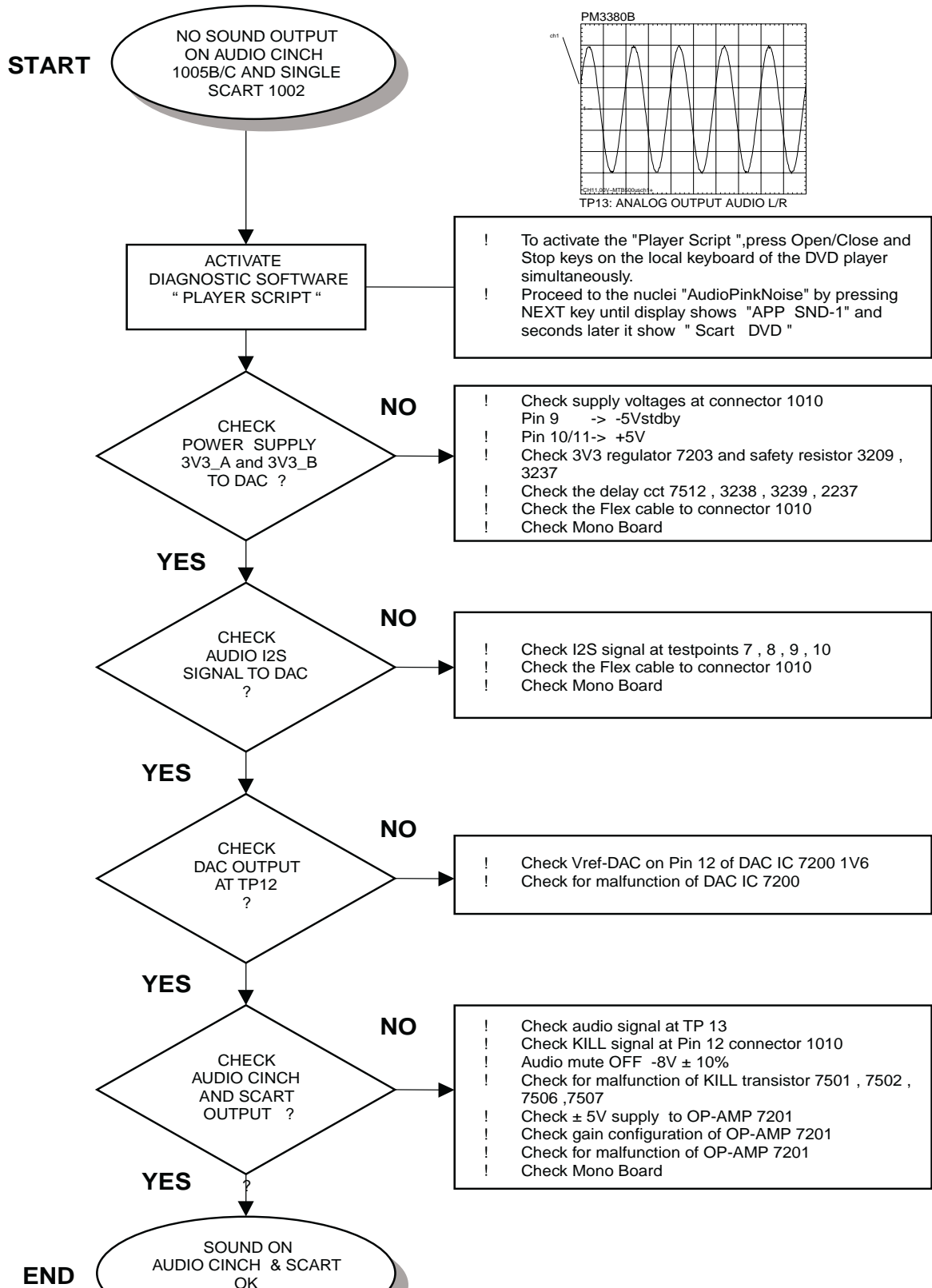

AUDIO WAVEFORM MEASUREMENT

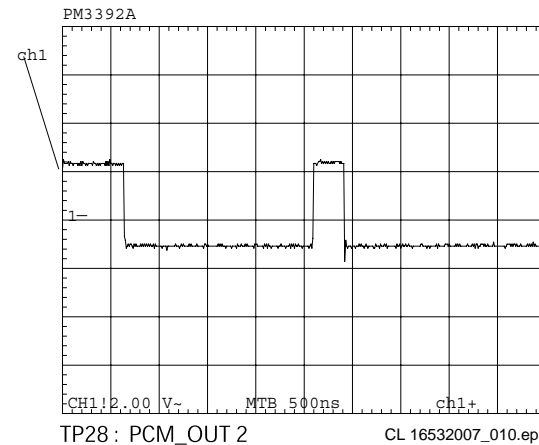
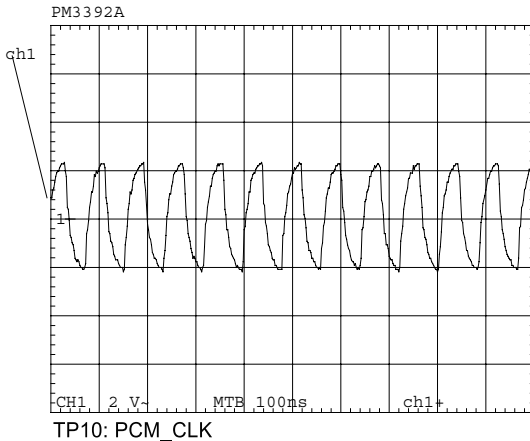
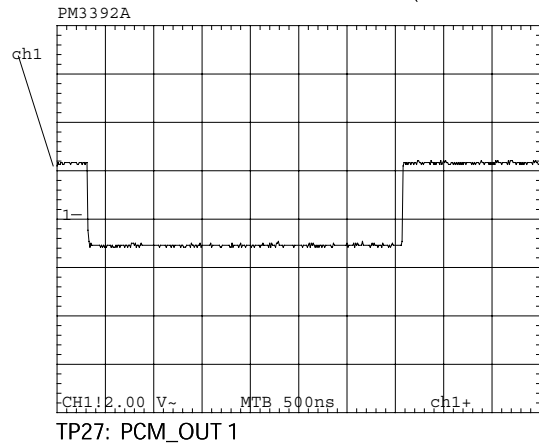
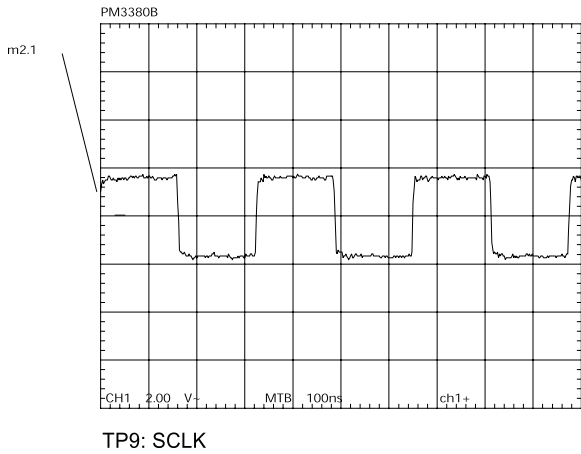
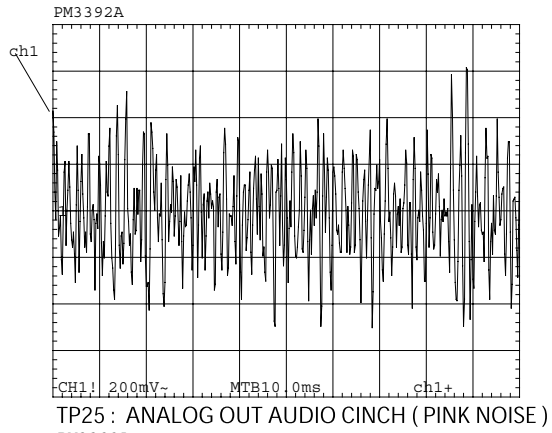
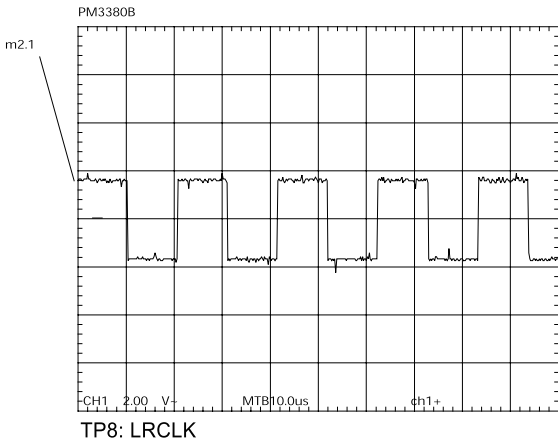
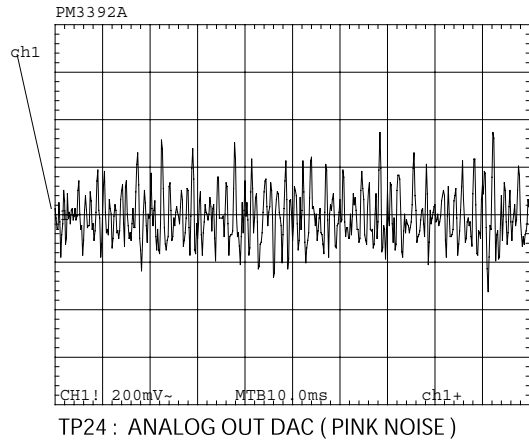
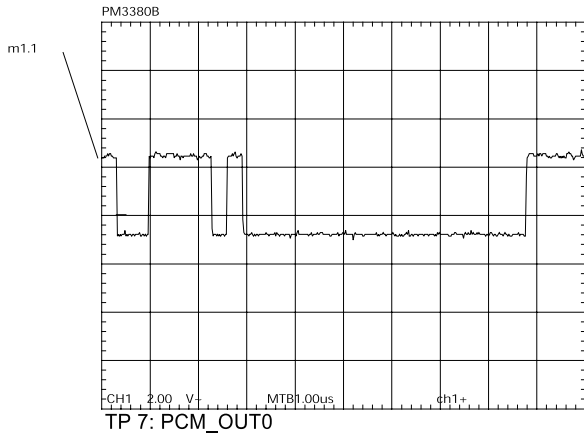

AUDIO PART OF AUDIO/VIDEO BOARD 3139 243 30241

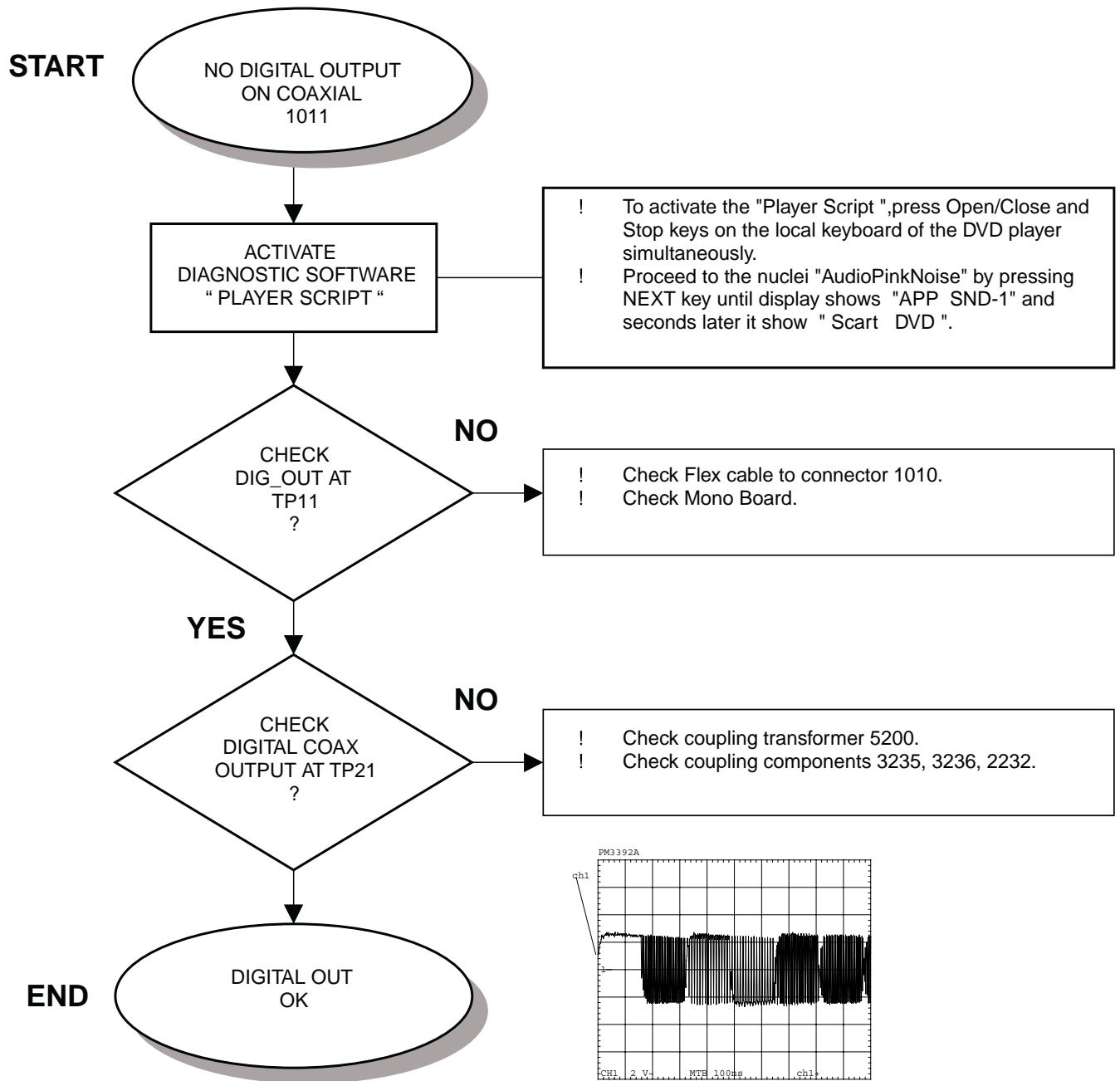

! To activate the "Player Script ",press Open/Close and Stop keys on the local keyboard of the DVD player simultaneously.
! Proceed to the nuclei "AudioPinkNoise" by pressing NEXT key until display shows "APP SND-1" and seconds later it show " Scart DVD ".

! Check Flex cable to connector 1010.
! Check Mono Board.

! Check coupling transformer 5200.
! Check coupling components 3235, 3236, 2232.

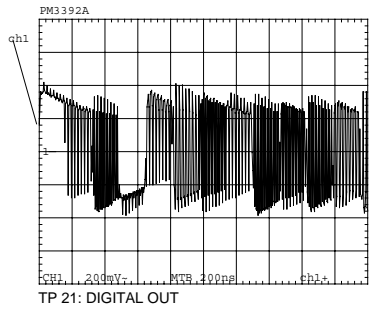
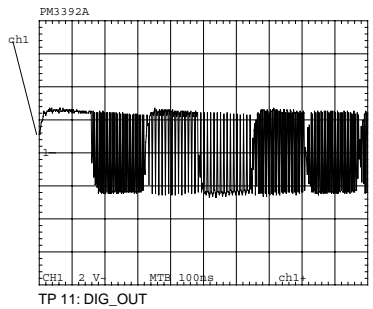

VIDEO PART OF AUDIO/VIDEO BOARD 3139 243 30241

START

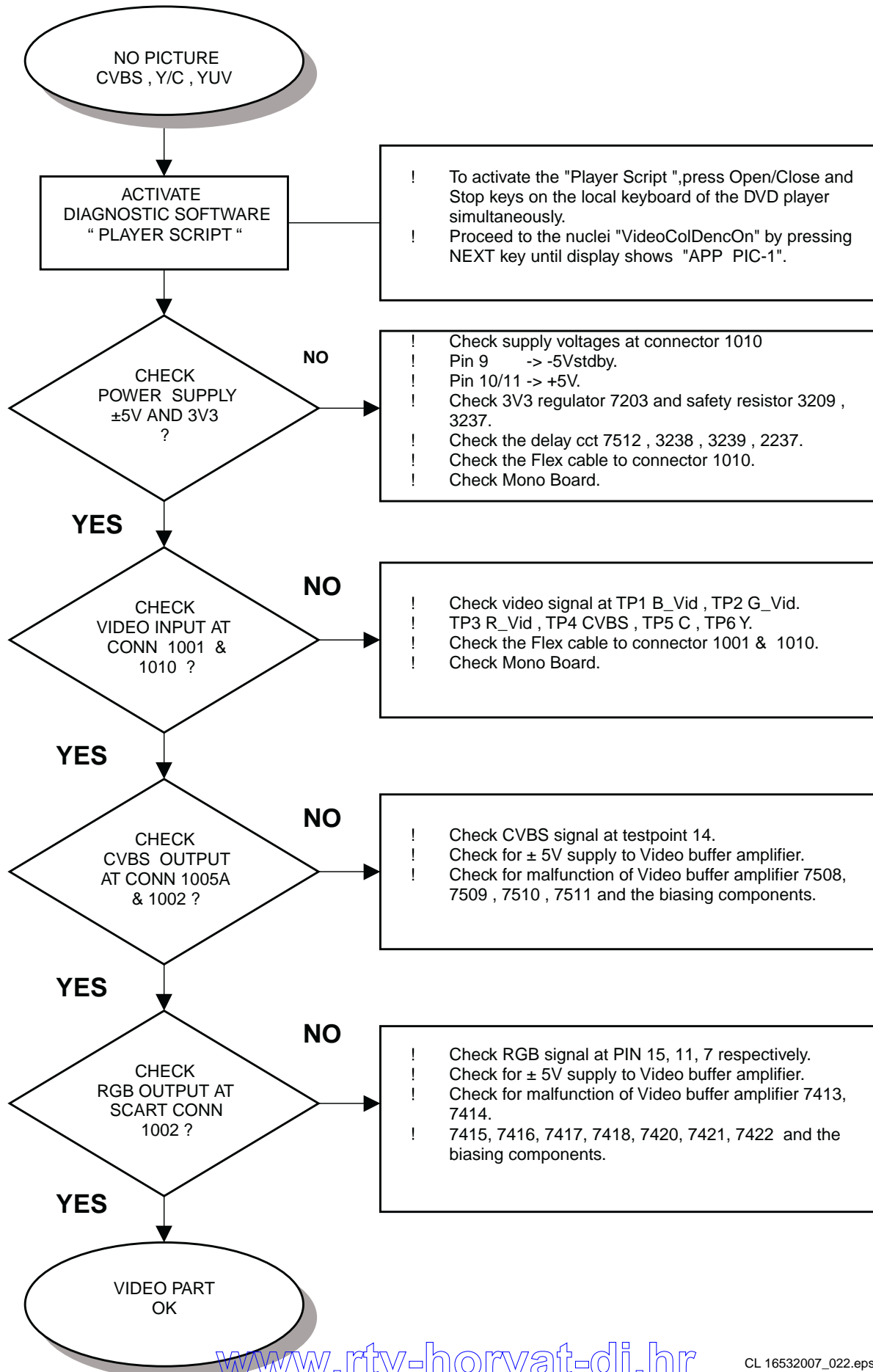

VIDEO WAVEFORM MEASUREMENT

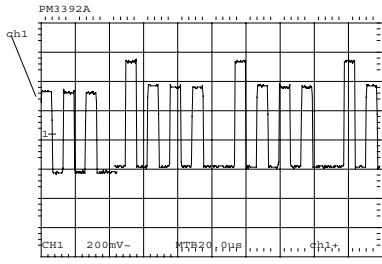

TP 1: VIDEO B

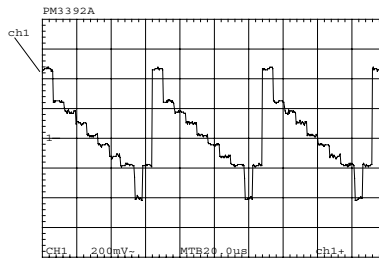

TP 6: Y_ENC

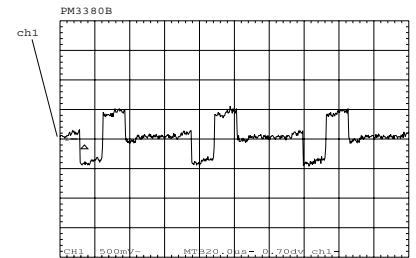

TP 19: V_VID OUT

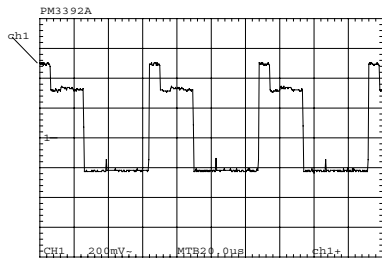

TP 2: VIDEO G

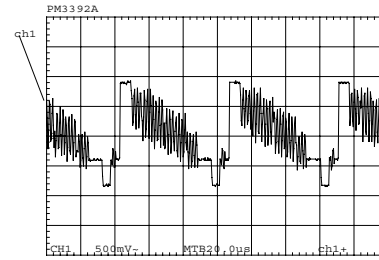

TP 14: CVBS_OUT

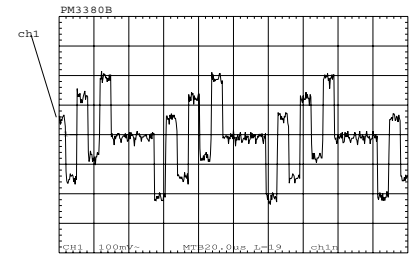

TP 22: U_VID

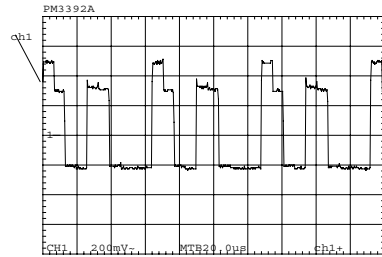

TP 3: VIDEO R

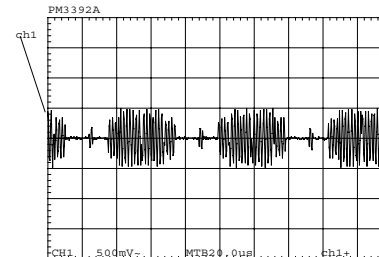

TP 15: C_OUT

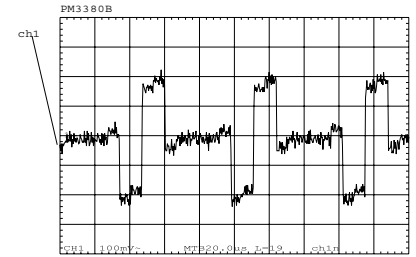

TP 23: V_VID

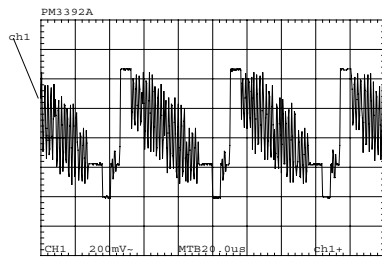

TP 4: CVBS

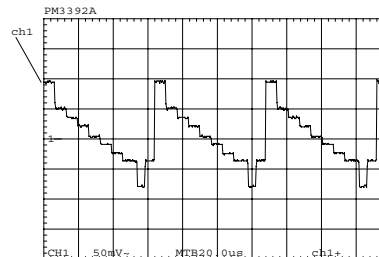

TP 16/17: Y_OUT

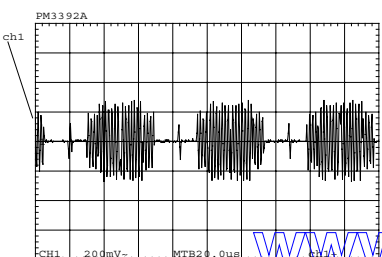

TP 5: C_ENC

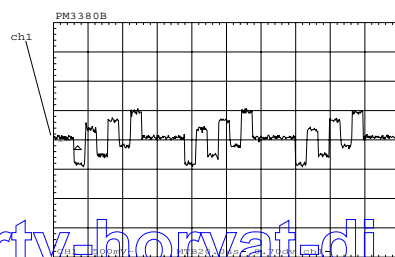

TP 18: U_VID OUT

TROUBLESHOOTING POWER SUPPLY UNIT VFM EURO

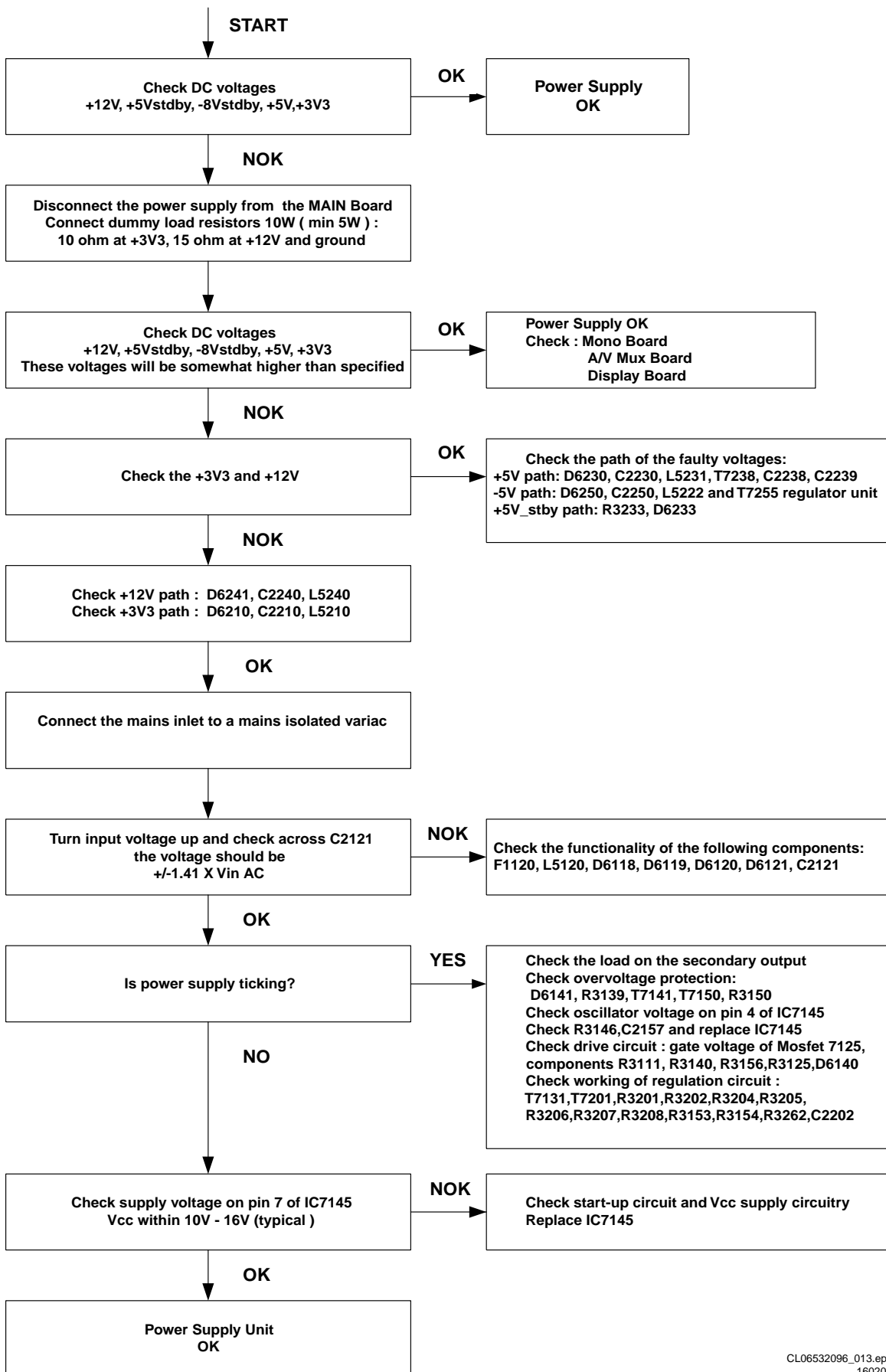

6. Block- and wiringdiagram.

Blockdiagram DVD 612 /XX1

Block Diagram DVD612/XX1

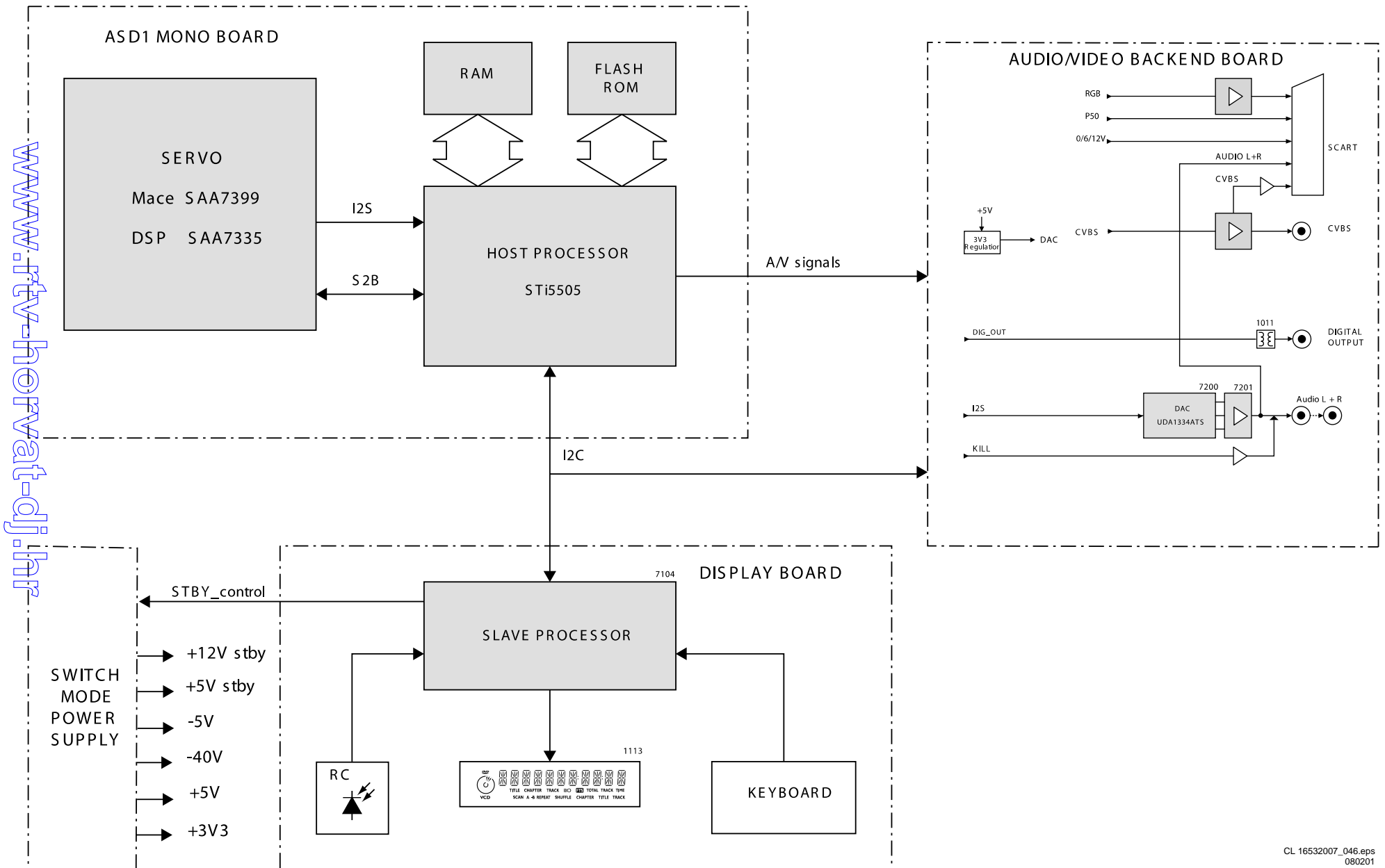

www.fv-horvat-dj.hr

Wiringdiagram

www.rtv-horvat-dj.hr

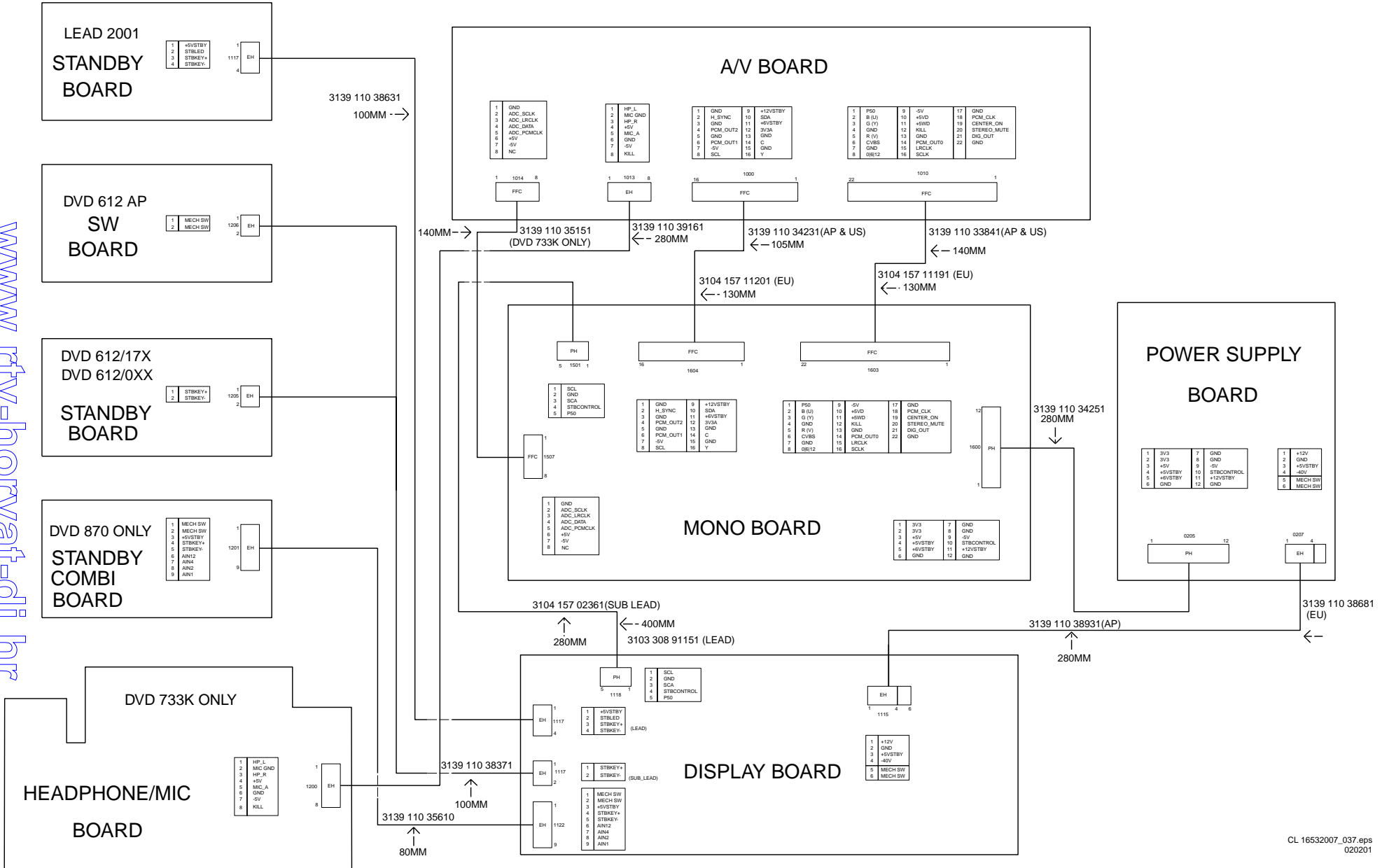

7. Electrical diagrams and Print-layouts

Power Supply Unit VFM EURO (3122 427 22570)

www.rtv-horvat-dj.hr

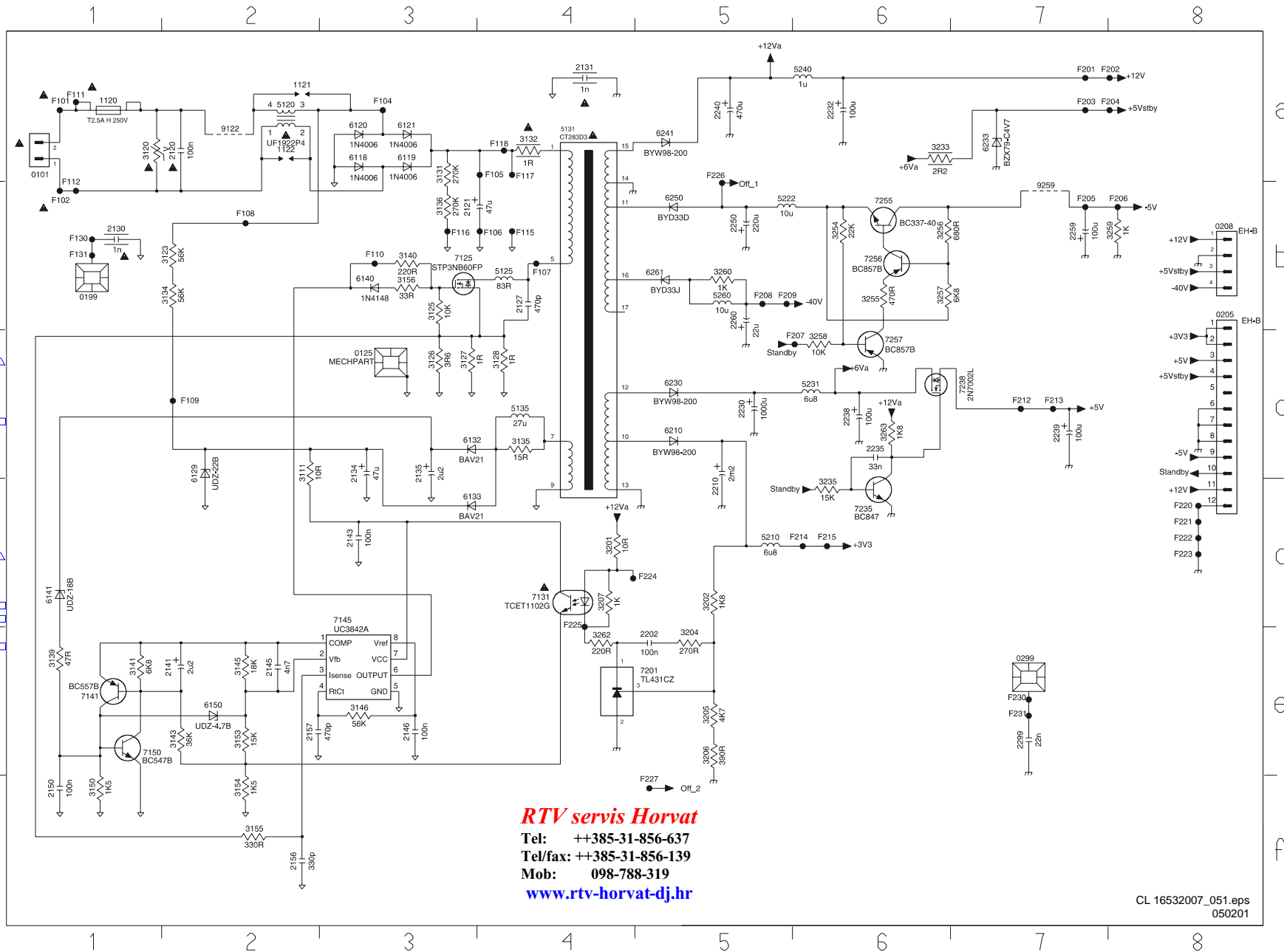

RTV servis Horvat

Tel: ++385-31-856-637

Tel/fax: ++385-31-856-139

Mob: 098-788-319

www.rtv-horvat-dj.hr

A/V Board (Video control & SCART)

A1 AV_VIDEO

www.rftv-norvat-dj.hr

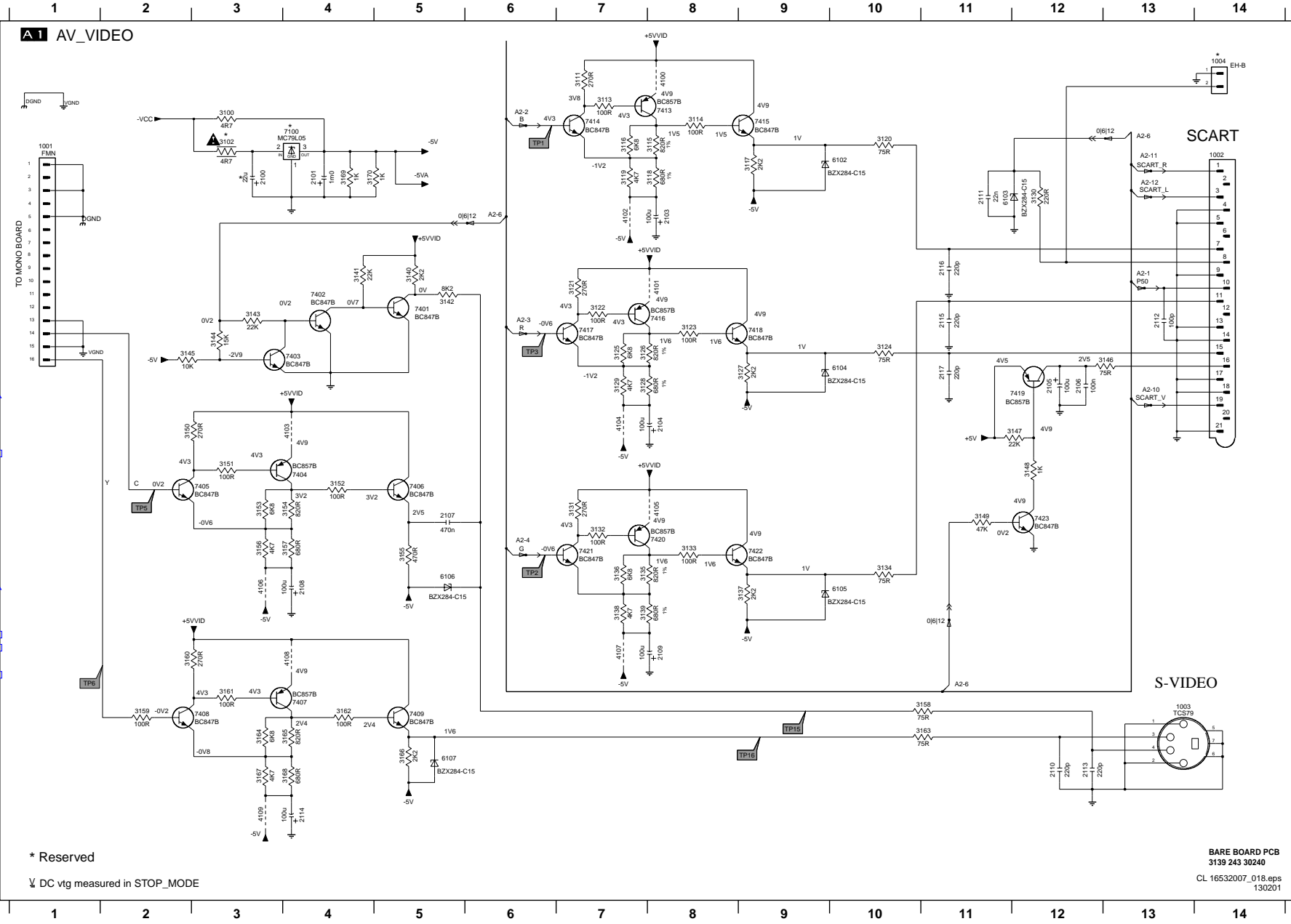

* Reserved
 ↓ DC vtg measured in STOP_MODE

BARE BOARD PCB
 3139 243 30240
 CL 16532007_018.eps
 130201

- 1001 B1
- 1002 B14
- 1003 H13
- 1004 A14
- 2100 B3
- 2101 B4
- 2103 B8
- 2104 E8
- 2105 D12
- 2106 D12
- 2107 F5
- 2108 F4
- 2109 G8
- 2110 H12
- 2111 B11
- 2112 C13
- 2113 H12
- 2114 I4
- 2115 C11
- 2116 C11
- 2117 D11
- 3100 A3
- 3102 B3
- 3111 A7
- 3113 A7
- 3114 A8
- 3115 B8
- 3116 B7
- 3117 B9
- 3118 B8
- 3119 B7
- 3120 A10
- 3121 C7
- 3122 C7
- 3123 D8
- 3124 D10
- 3125 D7
- 3126 D7
- 3127 D9
- 3128 D7
- 3129 D7
- 3130 B12
- 3131 F7
- 3132 F7
- 3133 F8
- 3134 F10
- 3135 F7
- 3136 F7
- 3137 F9
- 3138 B7
- 3139 G7
- 3140 C5
- 3141 C4
- 3142 C5
- 3143 C3
- 3144 D3
- 3145 D2
- 3146 D13
- 3147 E12
- 3148 E12
- 3149 F11
- 3150 E2
- 3151 E3
- 3152 E4
- 3153 F3
- 3154 F4
- 3155 F5
- 3156 F3
- 3157 F4
- 3158 H11
- 3159 H2
- 3160 G2
- 3161 H3
- 3162 H4
- 3163 H11
- 3164 H3
- 3165 H4
- 3166 H5
- 3167 H3
- 3168 H4
- 3169 B4
- 3170 B4
- 4100 A8
- 4101 G8
- 4102 B7
- 4103 E4
- 4104 E7
- 4105 F8
- 4106 F3
- 4107 G7
- 4108 G4
- 4109 I3
- 6102 B10
- 6103 H11
- 6104 D10
- 6105 F10
- 6106 F5
- 6107 H5
- 7100 A4
- 7401 C5
- 7402 C4
- 7403 D4
- 7404 E4
- 7405 E3
- 7406 E5
- 7407 H4
- 7408 H3
- 7409 H5
- 7413 A8
- 7414 A7
- 7415 A9
- 7416 C3
- 7417 D7
- 7418 D9
- 7419 D11
- 7420 F8
- 7421 F7
- 7422 F9
- 7423 F9
- 7423 F12

A/V Board (Sound)

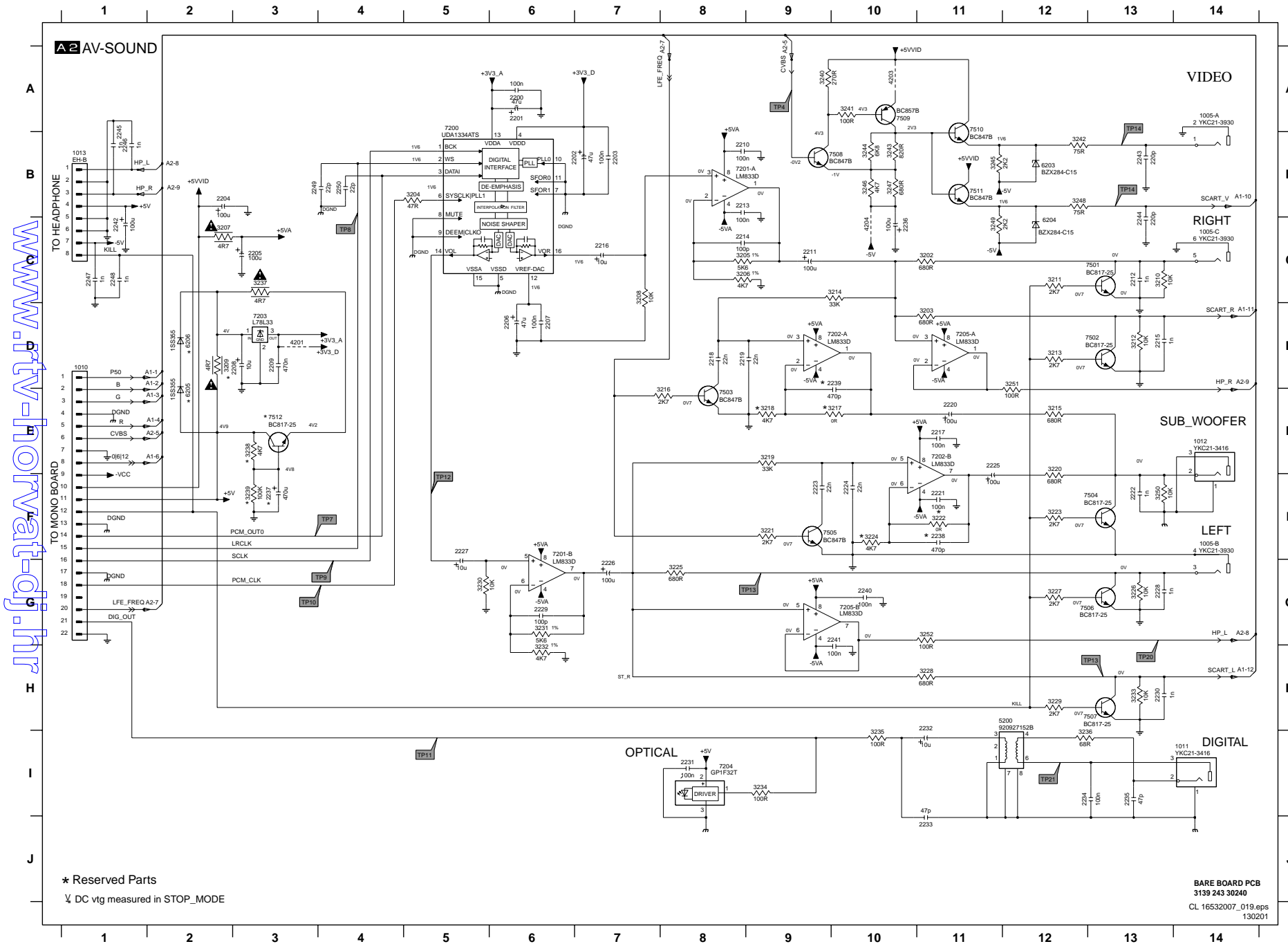

- 1005-A A14
- 1005-B F14
- 1005-C C14
- 1010 D1
- 1011 H1
- 1012 E14
- 1013 B1
- 2200 A6
- 2201 A6
- 2202 B7
- 2203 B7
- 2204 B2
- 2205 C3
- 2206 D6
- 2207 D6
- 2208 D3
- 2209 D3
- 2210 B8
- 2211 C9
- 2212 C13
- 2213 B8
- 2214 C8
- 2215 D13
- 2216 C7
- 2217 E11
- 2218 D8
- 2219 D8
- 2220 E11
- 2221 F11
- 2222 F13
- 2223 F9
- 2224 F10
- 2225 E11
- 2226 B7
- 2227 F5
- 2228 G13
- 2229 G6
- 2230 H13
- 2231 B8
- 2232 H11
- 2233 J11
- 2234 I12
- 2235 I13
- 2236 C10
- 2237 F3
- 2238 F11
- 2239 D10
- 2240 G10
- 2241 G10
- 2242 C1
- 2243 B13
- 2244 C13
- 2245 B1
- 2246 B1
- 2247 C1
- 2248 C1
- 2249 B3
- 2250 B4
- 3202 C11
- 3203 D11
- 3204 B5
- 3205 C8
- 3206 C8
- 3207 C2
- 3208 G7
- 3209 D2
- 3210 D13
- 3211 C12
- 3212 D13
- 3213 D12
- 3214 C10
- 3215 E12
- 3216 E8
- 3217 E10
- 3218 E9
- 3219 E9
- 3220 E12
- 3221 F9
- 3222 F11
- 3223 F12
- 3224 F10
- 3225 G8
- 3226 G13
- 3227 G12
- 3228 H11
- 3229 H12
- 3230 G5
- 3231 G6
- 3232 H6
- 3233 H13
- 3234 I9
- 3235 I10
- 3236 I12
- 3237 C3
- 3238 E3
- 3239 F3
- 3240 A9
- 3241 A10
- 3242 B12
- 3243 B10
- 3244 B10
- 3245 B11
- 3246 B10
- 3247 B10
- 3248 B12
- 3249 C11
- 3250 F13
- 3251 D12
- 3252 G11
- 4201 D3
- 4203 A10
- 4204 C10
- 5200 H11
- 6203 B12
- 6204 C12
- 6205 E2
- 6206 D2
- 7200 A3
- 7201-A B8
- 7201-B F6
- 7202-A D9
- 7202-B E11
- 7203 D3
- 7204 B8
- 7205-A D11

* Reserved Parts
 √ DC vtg measured in STOP_MODE

BARE BOARD PCB
 3139 243 30240
 CL 16532007_019.aps
 130201

www.rtv-horvat-dj.hr

Bare board Standby

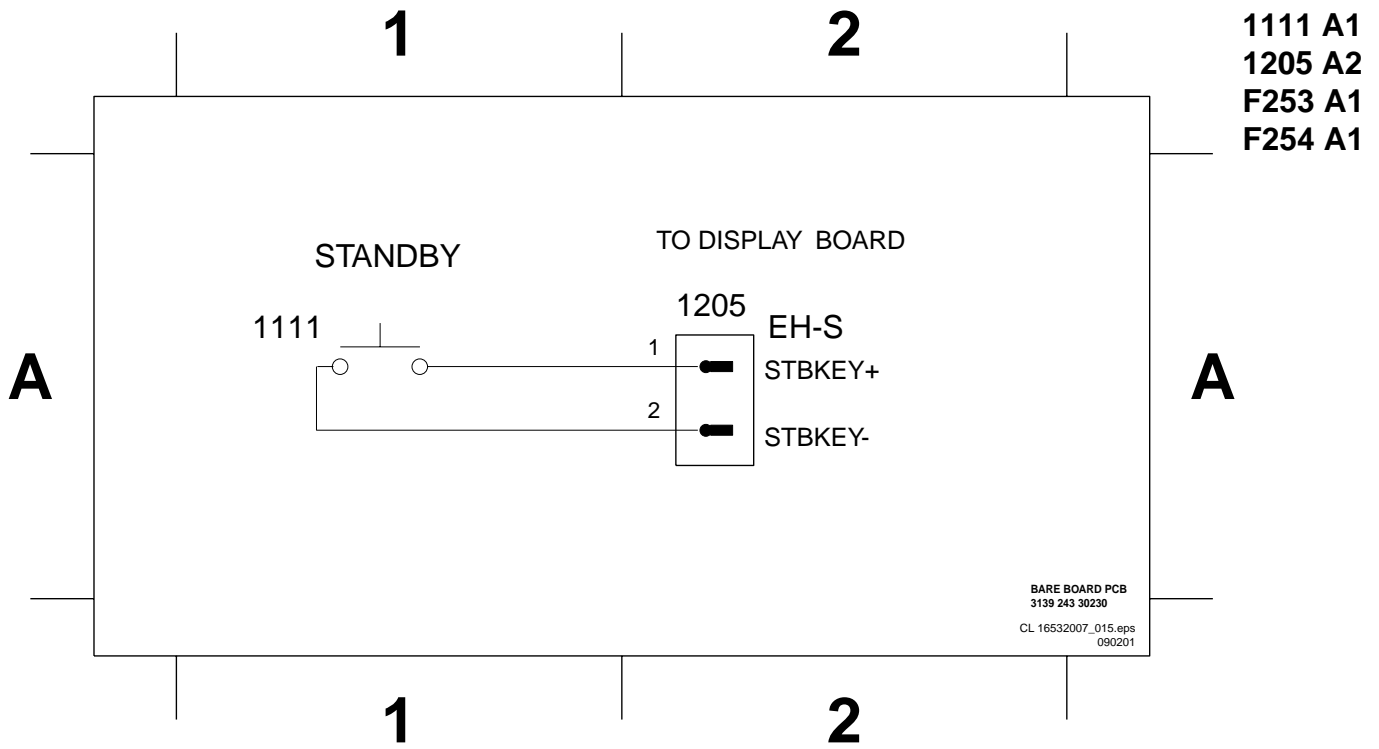

Layout Bare board Standby

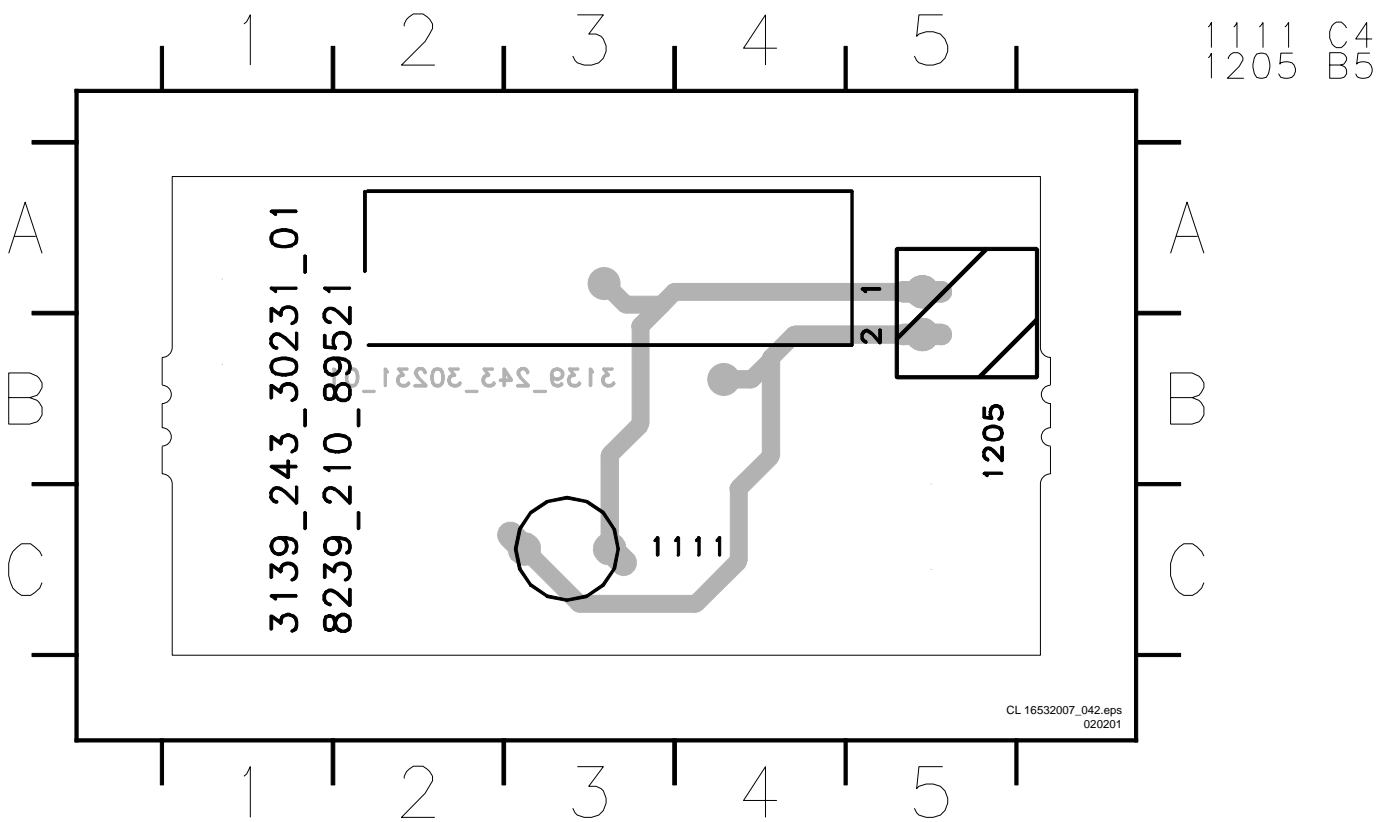

8. Alignments

No electrical alignments available

9. Circuit descriptions and list of abbreviations

9.1 Current mode Power Supply

9.1.1 Introduction

The switch mode power supply (SMPS) is mains isolated. The control IC 7145 (UC 3842A) produces pulses to drive the power switch, Mosfet 7125.

Power supply regulation is achieved by using duty cycle control at fix frequency ,of approximately 58KHz ,determined by the RC timing components.

9.1.2 General Description of UC 3842A

The UC 3842 is a high performance fixed frequency current mode controller that is specifically designed for off-line and

9.1.3 BLOCK DIAGRAM

DC-to-DC converter application. This integrated circuit feature a trimmed oscillator for precise duty cycle control, a temperature compensated reference, high gain error amplifier, current sensing comparator and a high current totem pole output ideally suited for driving a power MOSFET. Also included are protective features consisting of input and reference undervoltage lockouts each with hysteresis, cycle by cycle current limiting, programmable output deadtime and a latch for single pulse metering.

A representative Block diagram and Pin function description is shown in Fig 1 and Fig 2 respectively.

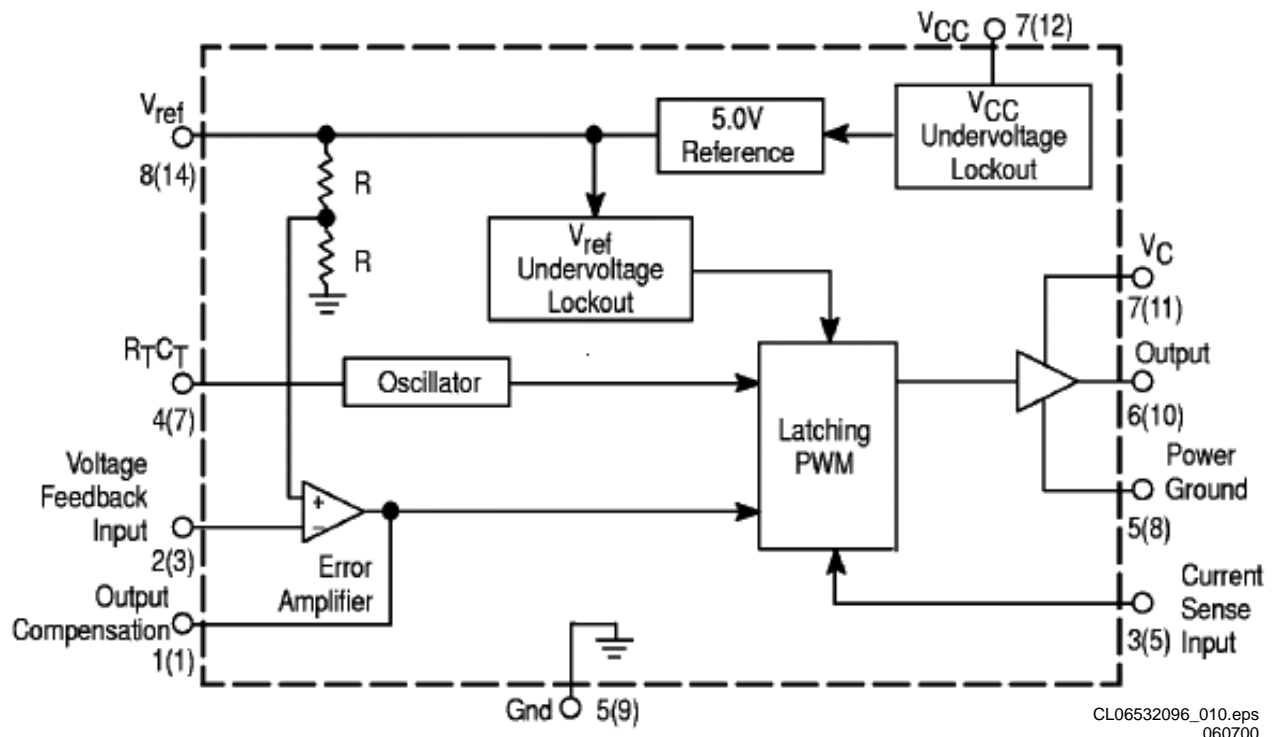

Figure 9-1

9.1.4 Pin function description

Pin		Function	Description
8-Pin	14-Pin		
1	1	Compensation	This pin is Error Amplifier output and is made available for loop compensation.
2	3	Voltage Feedback	This is the inverting input of the Error Amplifier. It is normally connected to the switching power supply output through a resistor divider.
3	5	Current Sense	A voltage proportional to inductor current is connected to this input. The PWM uses this information to terminate the output switch conduction.
4	7	R_T/C_T	The Oscillator frequency and maximum Output duty cycle are programmed by connecting resistor R_T to V_{ref} and capacitor C_T to ground. Operation to 500 kHz is possible.
5	-	Gnd	This pin is the combined control circuitry and power ground (8-pin package only).
6	10	Output	This output directly drives the gate of a power MOSFET. Peak currents up to 1.0 A are sourced and sunk by this pin.
7	12	V_{CC}	This pin is the positive supply of the control IC.
8	14	V_{ref}	This is the reference output. It provides charging current for capacitor C_T through resistor R_T .
-	8	Power Ground	This pin is a separate power ground return (14-pin package only) that is connected back to the power source. It is used to reduce the effects of switching transient noise on the control circuitry.
-	11	V_C	The Output high state (V_{OH}) is set by the voltage applied to this pin (14-pin package only). With a separate power source connection, it can reduce the effects of switching transient noise on the control circuitry.
-	9	Gnd	This pin is the control circuitry ground return (14-pin package only) and is connected back to the power source ground.
-	2,4,6,13	NC	No connection (14-pin package only). These pins are not internally connected.

CL06532096_011.eps
060700

Figure 9-2

9.1.5 Pin connection

CL06532096_012.eps
060700

Figure 9-3

9.1.6 Output voltages

- +12V (For Display board, Monoboard, A/V board) created via D6241, C2240, L5240, C2232 (This voltage is also present during standby)
- +5V_ stdby (For Display board, Standby PCB, Monoboard) created from +6V via R3233 and D6233 (This voltage is also present during standby)
- +6V_ stdby (Reserve) created from D6230, C2230, L5231 (This voltage is also present during standby)
- +5V (For Monoboard, A/V board) derive from +6V stdby via Mosfet 7238, C2239 and it will be switch off via R3235, T7235 during Standby.
- 5V (For Monoboard, A/V board) created from D6250, C2250, C2259, L5222, R3259, T7255 regulator circuit and will switch off via R3258, T7257 during standby (control signal Standby is HIGH)

- 3V3 (For Monoboard, A/V board) The 3V3 power supply is regulated by the control loop comprising of 7201, 7131 and 7145 of the switch mode PSU. This voltage is also present during standby
- 40V (For Display board) created via D6261, R3260, L5260, C2260 This will not be present during standby

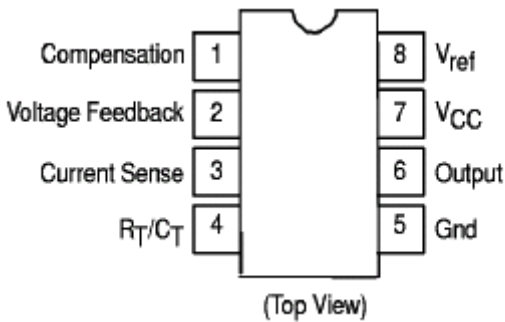
9.2 CONTROL CIRCUITRY

9.2.1 Mains input circuit

The mains voltage is rectified by bridge rectifier (D6118 to D6121) and filter by C2121. The DC voltage across C2121 is the DC input voltage ,approximately 300V, is the DC input to pin 1 of transformer T5131. The mains input also consists of a lighting protection R3120.

9.2.2 Start-up and takeover circuitry

The start-up circuitry consist R3123, R3134, R3111, D6129, C2134 and with the mains voltage input, the C2134 will charge via R3123 and R3134. When the voltage at pin 7 of IC7145 reaches the start-up threshold of min 14.5V, IC7145 will start-up and the control circuit start to operate. After start-up, the max sinking current of 17mA is required by IC7145 which is not able to be delivered by the start-up circuitry, so the takeover circuitry must be present. If the takeover circuit does not occurred, the supply voltage at pin 7 will decrease gradually till it reaches the IC7145 minimal operating voltage of 8.5V and the IC will switch off. The whole operation cycle will repeat itself with audible hiccup sound if takeover is not present.

The takeover circuit comprises of D6133, R3135, I5135, C2134. During the control circuit start-up, the voltage across winding pin 7 and 9 will gradually built up and charged C2134

via D6133, R3135 which will takeover the supply voltage of T7145 at pin 7.

it goes into the overvoltage protection and a complete restart sequence is required.

9.2.3 Secondary voltage sensing

The secondary voltage regulating circuit comprise of the opto-coupler 7131 which isolate the error signal from the control IC7145 ,on the primary side, and a reference component 7201 (TL431). The 7201 can be represented by two components:

- A very stable and accurate reference diode
- A high gain amplifier

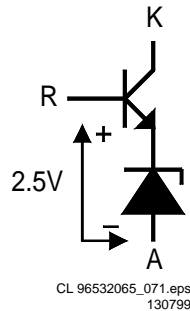

Figure 9-4

When the output voltage increases, due to a reduction in the load, the voltage across R3205 and R3206 increases to above the internal reference voltage of about 2.5V then TL431 conduct. The current through the opto-coupler 7131 will increase due to the fact that the series resistor in 7201 decreases. This result in a increase of voltage to pin 2 of IC7145, thus reducing the on-time of FET 7125. In the event of a decrease in output voltage (increase in load),the control circuit will operate in the opposite way to the explanation above.

9.2.4 Primary current sensing

The current through the FET 7125 resulting in a voltage drop across R3126,R3127,R3128 which is couple to pin 3 of IC7145,current sense input.The higher the input voltage, the more the primary current is limited. In this way the maximum output power of the power supply is limited.

9.2.5 Undervoltage protection

Two undervoltage lockout comparators have been incorporated to guarantee that the IC7145 is fully functional before the output stage is enable. The supply voltage at pin 7 and reference voltage at pin 8 of IC7145 are each monitored by separate comparators with built-in hysteresis. If the supply voltage at pin 7 of IC7145 drops below 10V (typical), due to a secondary voltage is short-circuit or excessive load, the drive pulse at pin 6 of IC7145 will be disabled and the controller will switch off the complete SMPS.

Remarks : In the event of the overvoltage situation remaining present, the SMPS will go in sequence of protection,start- up cycle, protection and the cycle repeats. This effect is highly audible.

9.2.6 Overvoltage protection

The overvoltage circuitry comprising of D6141,R3139, R3150, R3141,T7141, T7150 which is used to detect an over voltage situation on the secondary side of the transformer. After start-up, when the voltage across C2135 exceeds 18V,the overvoltage circuit will trigger the internal latch circuit, pin 1 of IC7145 and the output buffer is disabled and

9.3 List of abbreviations

B	Buffered Video input Blue from DVD monoboard
BC_AUX	Blue or Chroma input from AUX-scart
BC_TV	Blue or Chroma output to TV-scart
C_ENC	Buffered Chroma input from DVD monoboard
CVBS	Buffered Composite video input from DVD monoboard
DC_OFF	Control signal to switch off $\hat{u}8V_{stby}$ and $+12V_{stby}$ during standby
DIG_OUT	Digital out
FBIN_AUX	Fast blanking input from AUX-scart
FBOU_TV	Fast blanking output to TV-scart
G	Buffered Video input Green from DVD monoboard
GIN_AUX	Video input Green from AUX-scart
GOUT_TV	Video output Green to TV-scart
HP_L	Audio output left to headphone and audio scart switch TEA6420
HP_R	Audio output right to headphone and audio scart switch TEA6420
KILL	Kill control signal for audio outputs and for soft mute of DAC
LIN_AUX	Audio input left from AUX-scart
LIN_TV	Audio input left from TV-scart
LOUT_AUX	Audio output left to AUX-scart
LOUT_TV	Audio output left to TV-scart
LRCLK	Left/Right clock
PCM_CLK	Audio system clock for DAC
PCM_OUT0	Audio serial output data
R	Buffered Video input Red from DVD monoboard
RCIN_TV	Red or Chroma input from TV-scart
RCOUT_TV	Red or Chroma output to TV-scart
RIN_AUX	Audio input right from AUX-scart
RIN_TV	Audio input right from TV-scart
ROUT_AUX	Audio output right to AUX-scart
ROUT_TV	Audio output right to TV-scart
SCL	I2C bus clock
SCLK	Audio serial bit clock
SDA	I2C bus data
SELECT	Control signal for video scart switches; high = TV, low = AUX
SELECT_HIGH	Control signal for switching fast blanking and slow blanking signals; high = TV, low = AUX
SLB_AUX	Slow blanking control signal from AUX-scart
SLB_TV	Slow blanking control signal to TV-scart
STANDBY	Control signal from ST15505 used to switch off $\hat{u}8V_{stby}$ and $+12V_{stby}$ during standby.
STEREO_L	Audio cinch output left
STEREO_R	Audio cinch output right
Y_ENC	Buffered Luma input from DVD monoboard
YCVBSIN_AUX	Luma or CVBS input from AUX-scart
YCVBSIN_TV	Luma or CVBS input from TV-scart
YCVBSOUT_AUX	Luma or CVBS output to AUX-scart
YCVBSOUT_TV	Luma or CVBS output to TV-scart
0/6/12	Scart switch control signal A/V board. 0V : loop through (AUX to TV), 6V : play 16:9 format, 12V : play 4:3 format

10. Spare parts list

DVD612 /001

Various

0010	3139 247 52811	CAB FRONT DVD612/00X PPT
0025	3139 247 52941	BTN STANDBY DVD612/00X PPT
0030	3139 247 52851	WINDOW DVD612/00X PPT
0040	3139 247 52911	BTN CONTROL DVD612/00X PPT
0200	3139 247 52771	FRONT ASSY DVD612/00X
0224	3139 247 53011	BACK PLATE DVD612/00X PPT
0232	3139 247 52991	COVER TOP DVD612/00X PPT
0261	4822 321 11139	POWER CORD
0333	4822 321 11357	AUDIO CORD SET
0382	3111 170 21992	SCART CABLE (L=1.10M) BMS
0384	3139 228 87051	PROD.ASSY RC19133001/01 PACKED
0387	3139 246 10681	IFU DVD612/00X
1002	3139 248 80861	PCBAS AV DVD612 EU
1003	3139 248 80941	PCBAS FR DVD612 EU
1005	3122 427 22572	PSU DVD VFM EURO
1014	3104 157 11190	CWAS FLEX DVD 22 130 32S

AV PWB

Various

1002	2422 025 12352	CON BM EURO H 21P F BK GRND-L
1005	4822 265 11566	3P YKC21-3930
1010	2422 025 16526	CON BM V 22P F 1.00 FFC 0.3 R
1011	4822 267 31729	

-II-

2101	4822 124 40207	100µF 20% 25V
2103	4822 124 40207	100µF 20% 25V
2104	4822 124 40207	100µF 20% 25V
2105	4822 124 40207	100µF 20% 25V
2106	4822 126 14305	100nF 10% 16V 0603
2109	4822 124 40207	100µF 20% 25V
2111	4822 126 14494	22nF 10% 25V 0603
2112	4822 122 31765	100pF 2% 63V
2115	4822 126 13883	220pF 5% 50V
2116	4822 126 13883	220pF 5% 50V
2117	4822 126 13883	220pF 5% 50V
2200	4822 126 14305	100nF 10% 16V 0603
2201	4822 124 80231	47µF 20% 16V
2202	4822 124 80231	47µF 20% 16V
2203	4822 126 14305	100nF 10% 16V 0603
2204	4822 124 23432	100µF 20% 10V
2205	4822 124 40207	100µF 20% 25V
2206	4822 124 80231	47µF 20% 16V
2207	4822 126 14305	100nF 10% 16V 0603
2208	4822 124 11947	10µF 20% 16V
2209	3198 017 44740	0603 10V 470nF COL
2210	4822 126 14305	100nF 10% 16V 0603
2211	4822 124 40207	100µF 20% 25V
2212	3198 016 31020	0603 25V 1nF
2213	4822 126 14305	100nF 10% 16V 0603
2214	4822 122 31765	100pF 2% 63V
2215	3198 016 31020	0603 25V 1nF
2216	4822 124 11947	10µF 20% 16V
2226	4822 124 40207	100µF 20% 25V
2227	4822 124 11947	10µF 20% 16V
2228	3198 016 31020	0603 25V 1nF
2229	4822 122 31765	100pF 2% 63V
2230	3198 016 31020	0603 25V 1nF
2232	4822 124 11947	10µF 20% 16V
2233	4822 122 33777	47pF 5% 63V
2234	4822 126 14305	100nF 10% 16V 0603
2235	4822 122 33777	47pF 5% 63V
2236	4822 124 40207	100µF 20% 25V
2237	4822 124 80195	470µF 20% 10V
2243	4822 126 13883	220pF 5% 50V
2244	4822 126 13883	220pF 5% 50V
2249	4822 122 33761	22pF 5% 50V



3100	4822 051 20008	0Ω jumper . (0805)
3111	4822 051 30271	270Ω 5% 0.062W
3113	4822 051 30101	100Ω 5% 0.062W
3114	4822 051 30101	100Ω 5% 0.062W
3115	4822 117 12968	820Ω 5% 0.62W
3116	4822 051 30682	6k8 5% 0.062W
3117	4822 051 30222	2k2 5% 0.062W
3118	4822 051 30681	680Ω 5% 0.062W
3119	4822 051 30472	4k7 5% 0.062W
3120	4822 051 30759	75Ω 5% 0.062W
3121	4822 051 30271	270Ω 5% 0.062W
3122	4822 051 30101	100Ω 5% 0.062W
3123	4822 051 30101	100Ω 5% 0.062W
3124	4822 051 30759	75Ω 5% 0.062W
3125	4822 051 30682	6k8 5% 0.062W
3126	4822 117 12968	820Ω 5% 0.62W
3127	4822 051 30222	2k2 5% 0.062W
3128	4822 051 30681	680Ω 5% 0.062W
3129	4822 051 30472	4k7 5% 0.062W
3130	4822 051 30221	220Ω 5% 0.062W
3131	4822 051 30271	270Ω 5% 0.062W
3132	4822 051 30101	100Ω 5% 0.062W
3133	4822 051 30101	100Ω 5% 0.062W
3134	4822 051 30759	75Ω 5% 0.062W
3135	4822 117 12968	820Ω 5% 0.62W
3136	4822 051 30682	6k8 5% 0.062W
3137	4822 051 30222	2k2 5% 0.062W
3138	4822 051 30472	4k7 5% 0.062W
3139	4822 051 30681	680Ω 5% 0.062W
3146	4822 051 30759	75Ω 5% 0.062W
3147	4822 051 30223	22k 5% 0.062W
3148	4822 051 30102	1k 5% 0.062W
3149	4822 116 83884	47k 5% 0.5W
3169	4822 051 30102	1k 5% 0.062W
3170	4822 051 30102	1k 5% 0.062W
3202	4822 051 30681	680Ω 5% 0.062W
3203	4822 116 52228	680Ω 5% 0.5W
3204	4822 116 52195	47Ω 5% 0.5W
3205	4822 117 12902	8k2 1% 0.063W 0603
3206	4822 051 30472	4k7 5% 0.062W
3207	4822 117 11152	4Ω7 5%
3208	4822 051 30103	10k 5% 0.062W
3210	4822 051 30103	10k 5% 0.062W
3211	4822 051 30272	2k7 5% 0.062W
3212	4822 051 30103	10k 5% 0.062W
3213	4822 051 30272	2k7 5% 0.062W
3225	4822 051 30681	680Ω 5% 0.062W
3226	4822 051 30103	10k 5% 0.062W
3227	4822 051 30272	2k7 5% 0.062W
3228	4822 116 52228	680Ω 5% 0.5W
3229	4822 116 52263	2k7 5% 0.5W
3230	4822 051 30103	10k 5% 0.062W
3231	4822 117 12902	8k2 1% 0.063W 0603
3232	4822 051 30472	4k7 5% 0.062W
3233	4822 051 30103	10k 5% 0.062W
3235	4822 116 52175	100Ω 5% 0.5W
3236	4822 051 30689	68Ω 5% 0.063W 0603 RC21 RST SM
3237	4822 117 11152	4Ω7 5%
3238	4822 051 30472	4k7 5% 0.062W
3239	4822 117 13632	100k 1% 0603 0.62W
3240	4822 051 30271	270Ω 5% 0.062W
3241	4822 051 30101	100Ω 5% 0.062W
3242	4822 051 30759	75Ω 5% 0.062W
3243	4822 117 12968	820Ω 5% 0.62W
3244	4822 051 30682	6k8 5% 0.062W
3245	4822 051 30222	2k2 5% 0.062W
3246	4822 051 30472	4k7 5% 0.062W
3247	4822 051 30681	680Ω 5% 0.062W
3248	4822 051 30759	75Ω 5% 0.062W
3249	4822 051 30222	2k2 5% 0.062W
4xxx	4822 051 10008	0Ω 5% 0.25W (1206)
4xxx	4822 051 20008	0Ω 5% 0.25W (0805)



5200 4822 157 70601 100µH (920927085A)

6102 4822 130 11522 UDJ15B
6103 4822 130 11522 UDJ15B

Front PWB

Various

1100	4822 276 13775	SWITCH
1101	4822 276 13775	SWITCH
1102	4822 276 13775	SWITCH
1106	4822 276 13775	SWITCH
1107	4822 276 13775	SWITCH
1108	4822 276 13775	SWITCH
1109	4822 276 13775	SWITCH
1110	2422 540 98423	RES CER 8MHz CSTS*MHz 03
1111	4822 276 13775	SWITCH
1113	3139 240 50021	FTD 11-MT-126GNK DVD602
1115	4822 267 10565	4P
1117	2412 020 00724	CON BM V 2P M 2.50 EH B
1118	4822 267 10637	B5B-PH-K (5P)
1205	2422 025 12488	CON BM H 2P M 2.50 EH B

-II-

2100	4822 126 13883	220pF 5% 50V
2101	4822 126 13883	220pF 5% 50V
2105	4822 126 14549	33nF 16V O6O3
2106	4822 124 40207	100µF 20% 25V
2107	3198 024 44730	47nF 50V 0603
2108	3198 024 44730	47nF 50V 0603
2109	3198 024 44730	47nF 50V 0603
2110	3198 024 44730	47nF 50V 0603
2111	3198 024 44730	47nF 50V 0603
2114	4822 122 33761	22pF 5% 50V
2115	4822 122 33761	22pF 5% 50V
2116	4822 126 14549	33nF 16V O6O3
2122	4822 126 14549	33nF 16V O6O3
2123	4822 124 40207	100µF 20% 25V
2124	3198 028 42290	EL 5MM 35V 22µF PM20 COL A
2125	4822 122 33761	22pF 5% 50V
2126	4822 124 11947	10µF 20% 16V
2128	5322 126 11578	1nF 10% 50V 0603
2129	3198 028 42290	EL 5MM 35V 22µF PM20 COL A
2130	4822 124 41751	47µF 20% 50V
2201	4822 126 14549	33nF 16V O6O3



3100	4822 051 30223	22k 5% 0.062W
3101	4822 051 30273	27k 5% 0.062W
3102	4822 117 12925	47k 1% 0.063W 0603
3103	4822 117 13608	4.7Ω 5% 0603 0.0016W
3104	4822 117 13632	100k 1% 0603 0.62W
3105	4822 117 13613	2Ω2 5% 0603
3106	4822 051 30221	220Ω 5% 0.062W
3107	4822 117 13608	4.7Ω 5% 0603 0.0016W
3108	4822 117 13613	2Ω2 5% 0603
3109	4822 051 30472	4k7 5% 0.062W
3110	4822 051 30472	4k7 5% 0.062W
3111	4822 051 30472	4k7 5% 0.062W
3112	4822 051 30472	4k7 5% 0.062W
3113	4822 051 30472	4k7 5% 0.062W
3114	4822 051 30109	10Ω 5% 0.062W
3115	4822 051 30472	4k7 5% 0.062W
3118	4822 051 30103	10k 5% 0.062W
3119	4822 051 30103	10k 5% 0.062W
3120	4822 051 30471	470Ω 5% 0.062W
3121	4822 051 30472	4k7 5% 0.062W
3122	4822 051 30109	10Ω 5% 0.062W
3123	4822 051 30103	10k 5% 0.062W
3125	4822 051 30109	10Ω 5% 0.062W
3130	4822 051 30109	10Ω 5% 0.062W
3132	4822 051 30331	330Ω 5% 0.062W
3133	4822 051 30109	10Ω 5% 0.062W
3134	4822 051 30331	330Ω 5% 0.062W
3136	4822 051 30102	1k 5% 0.062W
3138	4822 051 30471	470Ω 5% 0.062W
3139	4822 051 30472	4k7 5% 0.062W
3140	4822 051 30103	10k 5% 0.062W
3143	4822 051 30103	10k 5% 0.062W
3144	4822 117 13632	100k 1% 0603 0.62W
3146	4822 051 30103	10k 5% 0.062W
3147	4822 051 30103	10k 5% 0.062W
3148	4822 051 30101	100Ω 5% 0.062W
3149	4822 051 30101	100Ω 5% 0.062W

3155 4822 051 30008 0Ω jumper
3156 4822 051 30008 0Ω jumper
3159 4822 051 30472 4k7 5% 0.062W



6100 4822 130 11397 BAS316
6101 9965 000 04709 UD26.2BTE-17
6102 4822 130 10837 UDZS8.2B
6104 4822 130 11397 BAS316



7101 4822 130 60511 BC847B
7104 3104 123 94532 TMP87CH74F-1E29-V2.18-DVDSLAVE
7105 4822 130 40981 BC337-25
7106 4822 130 40854 BC327
7107 4822 130 60511 BC847B
7108 4822 130 60511 BC847B
7110 9322 155 98667 IR RECEIVER
TSOP2236YA1(VISH)L
7112 4822 209 31257 MC79L24ACP

PSU PWB

Various

0101▲ 4822 265 20723 B2P3-VH
0120▲ 4822 265 11253 FUSE HOLDER 2P
0205 2422 025 08333 CON BM V 12P M 2.50 EH
B
0208 4822 267 10565 4P
1120▲ 4822 253 30383 19181 (2,5A)



2120▲ 4822 121 10711 100nF 20% 275V
2121 2222 151 90048 47μF 20% 400V
2127 4822 122 50116 470pF 10% 1KV
2130▲ 4822 126 13841 1nF 20% 250V
2131▲ 4822 126 13841 1nF 20% 250V
2134 4822 124 11566 47μF 20% 50V
2135 4822 124 22652 2.2μF 20% 50V
2141 4822 124 22652 2.2μF 20% 50V
2143 4822 126 14585 100nF 10% 50V
2145 5322 126 10223 4.7nF 10% 63V
2146 4822 126 14585 100nF 10% 50V
2150 4822 126 14585 100nF 10% 50V
2156 5322 122 31863 63V 330pF PM5
2157 5322 122 32268 63V 470P PM5
2202 4822 126 14585 100nF 10% 50V
2210 2020 012 93728 EL YK 10V S 2200μF PM20
B
2230 2020 012 93757 EL YK 10V S 1000μF PM20
B
2232 4822 124 81021 100μF 20% 16V
2235 4822 126 14549 33nF 16V O6O3
2238 4822 124 81021 100μF 20% 16V
2239 4822 124 81021 100μF 20% 16V
2240 4822 124 81147 470μF 20% YK 25V
2250 4822 124 41545 220μF 20% 16V
2259 4822 124 81021 100μF 20% 16V
2260 4822 124 81151 22μF 50V
2299 5322 122 32654 63V 22nF PM10 R



3111 4822 116 52176 10Ω 5% 0.5W
3120▲ 2322 595 90023 VDR DC 1M A/423V S MAX
800V B
3123 4822 116 52291 56k 5% 0.5W
3125 4822 051 20223 22k 5% 0.1W
3126 4822 116 81801 30Ω 5% 0.5W
3127 4822 116 80176 1Ω 5% 0.5W
3128 4822 116 80176 1Ω 5% 0.5W
3131 4822 051 10274 270k 2% 0.25W
3132▲ 4822 052 11108 1Ω 5% 0.5W
3134 4822 116 52291 56k 5% 0.5W
3135 4822 116 52182 15Ω 5% 0.5W
3136 4822 051 10274 270k 2% 0.25W
3137 4822 117 10837 100k 1% 0.1W
3139 4822 051 20479 47Ω 5% 0.1W
3140 4822 116 52226 560Ω 5% 0.5W
3141 4822 117 11507 6k8 1% 0.1W
3143 3198 021 53630 36k 5% 0.1W 0805
3145 4822 117 10965 18k 1% 0.1W
3146 4822 117 11148 56k 1% 0.1W
3150 4822 117 11139 1k5 1% 0.1W
3153 4822 116 83933 15k 1% 0.1W

3154 4822 117 11139 1k5 1% 0.1W
3155 4822 116 52219 330Ω 5% 0.5W
3156 4822 051 20339 33Ω 5% 0.1W
3201 4822 116 52176 10Ω 5% 0.5W
3202 4822 117 11141 1k8 1% 0.1W
3204 4822 117 11504 270Ω 1% 0.1W
3205 4822 117 11145 4k7 1% 0.1W
3206 4822 051 20391 390Ω 5% 0.1W
3207 4822 051 10102 1k 2% 0.25W
3233 4822 052 10228 2Ω 2% 5% 0.33W
3235 4822 116 83933 15k 1% 0.1W
3254 4822 051 30223 22k 5% 0.062W
3255 5322 117 13049 470Ω 1% 0.063W 0603
RC22H
3256 5322 117 13053 6k8 1% 0.063W 0603
RC22H
3257 4822 051 30563 56k 5% 0.062W
3258 4822 051 30103 10k 5% 0.062W
3259 4822 051 20102 1k 5% 0.1W
3260 4822 051 20101 100Ω 5% 0.1W
3262 4822 116 83872 220Ω 5% 0.5W
3263 4822 116 52249 1k8 5% 0.5W
4xxx 4822 051 10008 0Ω 5% 0.25W (1206)
4xxx 4822 051 20008 0Ω 5% 0.25W (0805)



5120▲ 4822 157 11846
5121▲ 4822 157 53348 TER CHOKE ASSY
CU15D3
5125 4822 157 11411 100mH z
5131▲ 3128 138 39631 SM TRANSFORMER -
CT282D4
5135 4822 157 70698 27μH
5210 2422 535 94638 IND FXD LHL08 S 6U8
PM20 A
5222▲ 4822 156 20966 47 μH
5231 2422 535 94638 IND FXD LHL08 S 6U8
PM20 A
5240 4822 157 51195 1 μH 20% 4X9.8MM AXIAL
5260 4822 157 11517 10μH 5% 2.3X3.4



6118 4822 130 31603 1N4006
6119 4822 130 31603 1N4006
6120 4822 130 31603 1N4006
6121 4822 130 31603 1N4006
6129 9340 548 67115 DIO REG SM PDZ22B
(PHSE) R
6132 4822 130 30842 BAV21
6133 4822 130 30842 BAV21
6140 4822 130 30621 1N4148
6141 4822 130 11152 UD218B
6150 4822 130 11148 UDZ4.7B
6210 4822 130 11584 BYW98-200-C1
6230 4822 130 41602 BYW95C
6233 4822 130 34174 BZX79-B4V7
6241 4822 130 11584 BYW98-200-C1
6250 4822 130 42488 BYD33D
6261 4822 130 42606 BYD33J



7125 4822 130 11417 STP3NB60FP
7131▲ 9322 149 04682 OPT CP TCET1102(G)
(VISH) L
7141 4822 130 44568 BC557B
7145 9322 145 88682 UC3842A
7150 4822 130 44257 BC547
7201 4822 209 81397 TL431CLPST
7235 4822 130 42705 BC847
7255 4822 130 40855 BC337
7256 5322 130 42756 BC857C
7257 5322 130 42756 BC857C

VAL 6011

Various

0001 9305 023 61101 VAL6011/01

MONO PWB

Various

1104 2422 025 75963 CON BM H 24P F 0.50 FFC
SMD R

1106 2422 025 16158 CON BM H 8P F 1.00 FFC
0.3 R
1205 2422 540 98428 RES CER SM 8M467
CSTCC8.46MHz R
1300 2422 540 98426 RES CER SM 6MHz
CSTCC6.00MHz R
1301 4822 267 51454 CONN. 11P FEMALE
1603 2422 025 16389 CON BM V 22P F 1.00 FFC
0.3 R
1604 2422 025 16388 CON BM V 16P F 1.00 FFC
0.3 R



2100 4822 126 14305 100nF 10% 16V 0603
2101 4822 126 14305 100nF 10% 16V 0603
2103 4822 124 80151 47μF 16V
2104 4822 126 13193 4.7nF 10% 63V
2105 4822 122 33761 22pF 5% 50V
2107 4822 126 13956 68pF 5% 63V CASE 0603
2108 4822 126 14315 390pF 5% 50V 0603
2109 2020 552 95697
2110 2222 861 15222 63V 2N2 PM5
2111 4822 126 14305 100nF 10% 16V 0603
2112 5322 126 11578 1nF 10% 50V 0603
2113 4822 126 14305 100nF 10% 16V 0603
2114 4822 122 31765 100pF 2% 63V
2115 4822 126 14305 100nF 10% 16V 0603
2116 4822 126 14305 100nF 10% 16V 0603
2117 4822 126 14305 100nF 10% 16V 0603
2118 3198 017 42230 0603 50V 22nF COL
2119 3198 017 42230 0603 50V 22nF COL
2120 4822 126 14305 100nF 10% 16V 0603
2121 4822 126 13879 220nF 20% 16V
2122 3198 017 42230 0603 50V 22nF COL
2123 4822 126 14305 100nF 10% 16V 0603
2124 4822 126 14305 100nF 10% 16V 0603
2125 4822 126 14305 100nF 10% 16V 0603
2126 4822 126 14305 100nF 10% 16V 0603
2127 4822 126 14305 100nF 10% 16V 0603
2128 4822 126 14508 180pF 5% 50V 0603
2129 4822 126 14508 180pF 5% 50V 0603
2130 4822 122 33761 22pF 5% 50V
2131 4822 126 14494 22nF 10% 25V 0603
2136 4822 126 14305 100nF 10% 16V 0603
2137 4822 126 14305 100nF 10% 16V 0603
2138 4822 126 14305 100nF 10% 16V 0603
2139 4822 126 14305 100nF 10% 16V 0603
2140 4822 126 14241 0603 50V 330P COL R
2141 4822 122 33761 22pF 5% 50V
2142 5322 126 11583 10nF 10% 50V 0603
2143 4822 126 13883 220pF 5% 50V
2144 4822 126 13883 220pF 5% 50V
2145 4822 126 13883 220pF 5% 50V
2146 4822 126 14305 100nF 10% 16V 0603
2203 4822 126 14305 100nF 10% 16V 0603
2204 4822 126 14305 100nF 10% 16V 0603
2205 4822 126 14305 100nF 10% 16V 0603
2206 4822 126 14549 33nF 16V O6O3
2207 5322 126 11578 1nF 10% 50V 0603
2208 4822 126 14305 100nF 10% 16V 0603
2209 4822 126 14305 100nF 10% 16V 0603
2210 5322 126 11578 1nF 10% 50V 0603
2212 4822 126 14305 100nF 10% 16V 0603
2213 4822 126 14305 100nF 10% 16V 0603
2214 3198 017 42230 0603 50V 22nF COL
2215 4822 124 23237 22μF 6.3V
2216 5322 126 11578 1nF 10% 50V 0603
2226 4822 126 14305 100nF 10% 16V 0603
2227 4822 126 14305 100nF 10% 16V 0603
2228 4822 126 14305 100nF 10% 16V 0603
2300 4822 126 14305 100nF 10% 16V 0603
2301 4822 126 14305 100nF 10% 16V 0603
2302 4822 126 14305 100nF 10% 16V 0603
2303 4822 124 80349 47μF 20% 6.3V
2304 3198 017 42230 0603 50V 22nF COL
2305 3198 017 42230 0603 50V 22nF COL
2306 4822 124 23002 10μF 16V
2307 3198 017 42230 0603 50V 22nF COL
2309 4822 126 14305 100nF 10% 16V 0603
2310 4822 126 14305 100nF 10% 16V 0603
2314 4822 126 14305 100nF 10% 16V 0603
2315 4822 126 14305 100nF 10% 16V 0603
2318 5322 122 33861 120pF 10% 50V
2319 4822 126 11669 27pF
2401 4822 126 14305 100nF 10% 16V 0603
2402 4822 126 14305 100nF 10% 16V 0603
2403 4822 126 14305 100nF 10% 16V 0603
2404 4822 126 14305 100nF 10% 16V 0603
2405 4822 126 14305 100nF 10% 16V 0603
2406 4822 126 14305 100nF 10% 16V 0603
2407 4822 126 14305 100nF 10% 16V 0603
2408 4822 126 14305 100nF 10% 16V 0603

2409	4822 126 14305	100nF 10% 16V 0603	3108	4822 051 20228	2Ω 5% 0.1W	3201	4822 117 11151	1Ω 5%
2410	4822 126 14305	100nF 10% 16V 0603	3110	4822 051 30479	47Ω 5% 0.062W	3202	4822 117 11151	1Ω 5%
2411	4822 126 14305	100nF 10% 16V 0603	3111	5322 117 13058	150Ω 1% 0.063W 0603 RC22H	3203	4822 051 30105	1M 5% 0.062W
2412	4822 126 14305	100nF 10% 16V 0603	3112	5322 117 13021	47Ω 1% 0.063W 0603 RC22H	3204	4822 051 30331	330Ω 5% 0.062W
2413	4822 126 14305	100nF 10% 16V 0603	3114	4822 051 20228	2Ω 5% 0.1W	3205	4822 051 30103	10k 5% 0.062W
2418	4822 124 12095	100μF 20% 16V	3115	4822 051 20228	2Ω 5% 0.1W	3206	4822 051 30103	10k 5% 0.062W
2419	4822 124 80349	47μF 20% 6.3V	3116	5322 117 13042	3k9 1% 0.063W 0603 RC22H	3208	4822 051 30272	2k7 5% 0.062W
2420	4822 124 80349	47μF 20% 6.3V	3117	4822 051 30181	180Ω 5% 0.062W	3209	4822 051 30472	4k7 5% 0.062W
2500	4822 126 14305	100nF 10% 16V 0603	3118	4822 051 30681	680Ω 5% 0.062W	3210	4822 051 30392	3k9 5% 0.063W 0603
2502	3198 030 74780	EL SM 35V 4U7 PM20 COL R	3119	5322 117 13062	390Ω 1% 0.063W 0603 RC22H	3211	4822 051 30472	4k7 5% 0.062W
2503	4822 126 14305	100nF 10% 16V 0603	3120	4822 051 30102	1k 5% 0.062W	3212	4822 117 11152	4Ω 7 5%
2504	4822 122 31765	100pF 2% 63V	3121	4822 051 30273	27k 5% 0.062W	3213	4822 117 11152	4Ω 7 5%
2505	4822 126 14494	22nF 10% 25V 0603	3122	4822 051 30471	470Ω 5% 0.062W	3214	4822 051 30392	3k9 5% 0.063W 0603
2506	4822 124 23002	10μF 16V	3123	4822 051 30103	10k 5% 0.062W	3215	4822 051 30103	10k 5% 0.062W
2507	4822 126 14305	100nF 10% 16V 0603	3124	4822 051 30103	470Ω 5% 0.062W	3219	4822 051 30103	10k 5% 0.062W
2508	5322 126 11579	3.3nF 10% 63V	3125	4822 051 30103	10k 5% 0.062W	3220	4822 051 30103	10k 5% 0.062W
2509	4822 126 14241	0603 50V 330P COL R	3126	4822 051 30103	10k 5% 0.062W	3221	4822 051 30103	10k 5% 0.062W
2510	4822 126 14305	100nF 10% 16V 0603	3127	4822 051 30103	22k 5% 0.062W	3224	4822 051 30151	150Ω 5% 0.062W
2511	4822 126 14305	100nF 10% 16V 0603	3128	2322 704 69109		3225	2322 704 62004	
2512	4822 126 14305	100nF 10% 16V 0603	3129	4822 051 30392	3k9 5% 0.063W 0603	3226	4822 051 30103	10k 5% 0.062W
2513	4822 126 14305	100nF 10% 16V 0603	3130	4822 051 20228	2Ω 5% 0.1W	3227	4822 051 30472	4k7 5% 0.062W
2514	4822 126 14305	100nF 10% 16V 0603	3131	4822 051 20228	2Ω 5% 0.1W	3229	4822 051 30123	12k 5% 0.062W
2515	4822 126 14305	100nF 10% 16V 0603	3132	4822 051 20228	2Ω 5% 0.1W	3230	4822 051 30103	10k 5% 0.062W
2516	4822 126 14305	100nF 10% 16V 0603	3133	4822 051 20228	2Ω 5% 0.1W	3231	4822 051 30103	10k 5% 0.062W
2517	4822 126 14305	100nF 10% 16V 0603	3134	5322 117 13047	330Ω 1% 0.063W 0603 RC22H	3232	4822 117 13613	2Ω 2 5% 0603
2518	4822 126 14305	100nF 10% 16V 0603	3135	4822 117 13613	2Ω 5% 0603	3234	4822 117 12902	8k2 1% 0.063W 0603
2519	4822 126 14305	100nF 10% 16V 0603	3137	4822 117 13613	2Ω 5% 0603	3235	4822 117 13632	100k 1% 0603 0.62W
2520	4822 126 14305	100nF 10% 16V 0603	3138	5322 117 13053	6k8 1% 0.063W 0603 RC22H	3236	4822 051 30472	4k7 5% 0.062W
2521	4822 126 14305	100nF 10% 16V 0603	3139	4822 117 12917	1Ω 5% 0.062W CASE0603	3237	4822 051 30103	10k 5% 0.062W
2522	4822 126 14305	100nF 10% 16V 0603	3140	4822 051 30479	47Ω 5% 0.062W	3238	4822 051 30103	10k 5% 0.062W
2523	4822 126 14305	100nF 10% 16V 0603	3141	4822 117 11152	4Ω 7 5%	3239	4822 051 30008	0Ω jumper
2524	4822 126 14305	100nF 10% 16V 0603	3142	5322 117 13028	12k 1% 0.063W 0603 RC22H	3240	4822 051 30103	10k 5% 0.062W
2525	4822 126 14305	100nF 10% 16V 0603	3143	5322 117 13043	220Ω 1% 0.063W 0603 RC22H	3242	4822 051 30008	0Ω jumper
2526	4822 126 14305	100nF 10% 16V 0603	3144	2322 704 69109		3243	4822 051 30008	0Ω jumper
2527	4822 126 14305	100nF 10% 16V 0603	3146	4822 051 30103	10k 5% 0.062W	3246	4822 051 30008	0Ω jumper
2528	4822 126 14305	100nF 10% 16V 0603	3147	4822 051 30103	10k 5% 0.062W	3247	4822 051 30008	0Ω jumper
2529	4822 126 14305	100nF 10% 16V 0603	3148	5322 117 13022	22k 1% 0.063W 0603 RC22H	3249	4822 051 30008	0Ω jumper
2530	3198 030 74780	EL SM 35V 4U7 PM20 COL R	3153	4822 117 12139	22Ω 5% 0.062W	3250	4822 051 30008	0Ω jumper
2531	3198 030 74780	EL SM 35V 4U7 PM20 COL R	3155	4822 051 30103	10k 5% 0.062W	3251	4822 051 30008	0Ω jumper
2532	4822 122 33777	47pF 5% 63V	3157	4822 051 30103	10k 5% 0.062W	3252	4822 051 30008	0Ω jumper
2533	4822 122 33777	47pF 5% 63V	3158	5322 117 13017	100Ω 1% 0.063W 0603 RC22H	3253	4822 051 30008	0Ω jumper
2534	5322 126 11578	1nF 10% 50V 0603	3160	4822 051 30101	100Ω 5% 0.062W	3254	4822 051 30008	0Ω jumper
2535	5322 126 11578	1nF 10% 50V 0603	3161	4822 117 13613	2Ω 5% 0603	3255	4822 051 30008	0Ω jumper
2600	4822 126 14494	22nF 10% 25V 0603	3162	4822 051 30101	100Ω 5% 0.062W	3256	4822 051 30008	0Ω jumper
2601	4822 126 14247	0603 50V 1N5 COL R	3163	4822 051 30273	27k 5% 0.062W	3257	4822 051 30008	0Ω jumper
2602	4822 126 14247	0603 50V 1N5 COL R	3164	4822 117 13613	2Ω 5% 0603	3258	4822 051 30008	0Ω jumper
2603	4822 126 14305	100nF 10% 16V 0603	3165	5322 117 13063	120Ω 1% 0.063W 0603 RC22H	3259	4822 117 11151	1Ω 5%
2604	4822 124 12095	100μF 20% 16V	3166	4822 051 30393	39k 5% 0.062W	3260	4822 117 11151	1Ω 5%
2605	4822 126 14494	22nF 10% 25V 0603	3167	4822 051 30101	100Ω 5% 0.062W	3261	4822 051 30102	1k 5% 0.062W
2606	4822 124 12095	100μF 20% 16V	3168	5322 117 13047	330Ω 1% 0.063W 0603 RC22H	3300	4822 117 11152	4Ω 7 5%
2607	4822 124 12095	100μF 20% 16V	3169	4822 051 30101	100Ω 5% 0.062W	3301	4822 051 30105	1M 5% 0.062W
2608	4822 124 23002	10μF 16V	3170	4822 051 30101	100Ω 5% 0.062W	3302	4822 051 30221	220Ω 5% 0.062W
2609	4822 124 80151	47μF 16V	3171	4822 051 30101	100Ω 5% 0.062W	3304	4822 051 30272	2k7 5% 0.062W
2610	4822 126 14305	100nF 10% 16V 0603	3172	4822 117 13632	100k 1% 0603 0.62W	3305	4822 051 30272	2k7 5% 0.062W
2611	4822 124 12095	100μF 20% 16V	3173	4822 117 13632	100k 1% 0603 0.62W	3309	4822 051 30103	10k 5% 0.062W
2614	4822 122 33777	47pF 5% 63V	3174	4822 117 11152	4Ω 7 5%	3310	4822 051 30223	22k 5% 0.062W
2615	4822 122 33777	47pF 5% 63V	3175	4822 117 13613	2Ω 5% 0603	3311	4822 051 30223	22k 5% 0.062W
2616	4822 122 33777	47pF 5% 63V	3176	4822 051 30153	15k 5% 0.062W	3312	4822 051 30472	4k7 5% 0.062W
2617	4822 122 33777	47pF 5% 63V	3178	4822 117 11151	1Ω 5%	3313	4822 051 30472	4k7 5% 0.062W
2618	4822 126 14305	100nF 10% 16V 0603	3179	4822 051 30221	220Ω 5% 0.062W	3316	4822 051 20108	1Ω 5% 0.1W
2620	4822 122 33777	47pF 5% 63V	3180	4822 117 13632	100k 1% 0603 0.62W	3317	4822 051 20108	1Ω 5% 0.1W
2621	4822 122 33777	47pF 5% 63V	3181	4822 051 30561	560Ω 5% 0.062W	3318	4822 051 30472	4k7 5% 0.062W
2622	4822 122 33777	47pF 5% 63V	3182	5322 117 13018	1k0 1% 0.063W 0603 RC22H	3319	4822 051 30479	47Ω 5% 0.062W
2623	4822 122 33777	47pF 5% 63V	3184	2322 704 61204		3320	4822 051 30472	4k7 5% 0.062W
2624	4822 122 33777	47pF 5% 63V	3185	4822 117 11151	1Ω 5%	3321	4822 051 30682	6k8 5% 0.062W
2625	4822 122 33777	47pF 5% 63V	3187	4822 051 30273	27k 5% 0.062W	3322	5322 117 13026	4k7 1% 0.063W 0603 RC22H
2626	4822 122 33777	47pF 5% 63V	3189	4822 051 30008	0Ω jumper	3323	5322 117 13026	4k7 1% 0.063W 0603 RC22H
2627	4822 122 33777	47pF 5% 63V	3190	4822 051 30008	0Ω jumper	3324	4822 117 13632	100k 1% 0603 0.62W
2632	4822 124 12095	100μF 20% 16V	3191	4822 051 30008	0Ω jumper	3325	4822 051 30682	6k8 5% 0.062W
2633	4822 124 12095	100μF 20% 16V	3192	4822 051 30008	0Ω jumper	3326	4822 051 30479	47Ω 5% 0.062W
2634	4822 126 14305	100nF 10% 16V 0603	3193	4822 051 30008	0Ω jumper	3327	4822 051 30682	6k8 5% 0.062W
2635	4822 126 14305	100nF 10% 16V 0603	3194	4822 051 30008	0Ω jumper	3328	4822 051 30223	22k 5% 0.062W
2636	4822 126 14305	100nF 10% 16V 0603	3195	4822 051 30008	0Ω jumper	3329	4822 051 30223	22k 5% 0.062W
2637	4822 126 14305	100nF 10% 16V 0603	3197	4822 051 30008	0Ω jumper	3330	4822 051 30223	22k 5% 0.062W
2638	4822 126 14305	100nF 10% 16V 0603	3198	5322 117 13049	470Ω 1% 0.063W 0603 RC22H	3331	4822 051 30332	3k3 5% 0.062W
2639	4822 126 14305	100nF 10% 16V 0603	3199	5322 117 13042	3k9 1% 0.063W 0603 RC22H	3332	4822 051 30332	3k3 5% 0.062W
2641	4822 122 33761	22pF 5% 50V	3200	4822 051 30103	10k 5% 0.062W	3333	4822 051 30101	100Ω 5% 0.062W
3100	4822 117 11152	4Ω 7 5%	3201	4822 117 11151	1Ω 5%	3334	4822 051 30101	100Ω 5% 0.062W
3102	5322 117 13034	1k5 1% 0.063W 0603 RC22H	3202	4822 117 11151	1Ω 5%	3335	4822 051 30101	100Ω 5% 0.062W
3103	5322 117 13034	1k5 1% 0.063W 0603 RC22H	3203	4822 051 30105	1M 5% 0.062W	3336	4822 051 30101	100Ω 5% 0.062W
3104	5322 117 13062	390Ω 1% 0.063W 0603 RC22H	3204	4822 051 30331	330Ω 5% 0.062W	3337	4822 051 30101	100Ω 5% 0.062W
3105	4822 051 30103	10k 5% 0.062W	3205	4822 051 30103	10k 5% 0.062W	3338	4822 051 30101	100Ω 5% 0.062W
3106	4822 051 30479	47Ω 5% 0.062W	3206	4822 051 30103	10k 5% 0.062W	3339	4822 051 30008	0Ω jumper
3107	4822 051 20228	2Ω 5% 0.1W	3208	4822 051 30272	2k7 5% 0.062W	3340	4822 051 30008	0Ω jumper
			3209	4822 051 30472	4k7 5% 0.062W	3403	4822 051 30103	10k 5% 0.062W
			3210	4822 051 30392	3k9 5% 0.063W 0603	3404	4822 051	

3502	4822 051 30223	22k 5% 0.062W	3657	2322 704 64301	RST SM 0603 RC22H 430Ω PM1 R	7208	9322 139 67685	IC SM MC33464N-45A (MOTA) R
3503	4822 051 30103	10k 5% 0.062W	3658	4822 051 30102	1k 5% 0.062W	7304	4822 209 16877	BA6856FP
3504	4822 051 30103	10k 5% 0.062W	3659	4822 051 30102	1k 5% 0.062W	7310	4822 209 15899	CY7C199-15C
3505	4822 051 30103	10k 5% 0.062W	3660	4822 051 30102	1k 5% 0.062W	7311	9352 637 83557	IC SM SAA7335HL/E/M2 (PHSE) Y
3506	4822 051 30103	10k 5% 0.062W	3661	2322 704 64301	RST SM 0603 RC22H 430Ω PM1 R	7312	4822 130 60373	BC856B
3507	4822 051 30472	4k7 5% 0.062W	3662	4822 051 30102	1k 5% 0.062W	7315	4822 130 60511	BC847B
3508	4822 051 30689	68Ω 5% 0.063W 0603 RC21 RST SM	3663	4822 051 30102	1k 5% 0.062W	7404	9322 144 59668	IC SM MT48LC1M16A1TG- 7S (MRN)R
3509	4822 051 30103	10k 5% 0.062W	3664	2322 704 64301	RST SM 0603 RC22H 430Ω PM1 R	7405	9322 144 59668	IC SM MT48LC1M16A1TG- 7S (MRN)R
3511	4822 051 30332	3k3 5% 0.062W	3665	4822 117 12139	22Ω 5% 0.062W	7501	4822 130 60511	BC847B
3512	4822 051 30332	3k3 5% 0.062W	3667	4822 051 30331	330Ω 5% 0.062W	7503	9322 151 16671	STI5505AVC
3513	4822 051 30103	10k 5% 0.062W	3669	4822 051 30008	0Ω jumper	7504	4822 242 10838	27MHZ 120P FX0-31FT
3514	4822 051 30103	10k 5% 0.062W	3671	4822 051 30222	2k2 5% 0.062W	7505	9322 156 81668	M24C32-WMN6TNKSA
3515	4822 051 30103	10k 5% 0.062W	3672	4822 051 30479	47Ω 5% 0.062W	7600	5322 209 71568	PC74HCT14T
3516	4822 051 30103	10k 5% 0.062W	3673	4822 051 30101	100Ω 5% 0.062W	7604	4822 130 60511	BC847B
3517	4822 051 30332	3k3 5% 0.062W	3677	4822 051 30008	0Ω jumper	7605	4822 209 17398	LD1117DTS33
3519	4822 051 30103	10k 5% 0.062W	3678	4822 051 30008	0Ω jumper	7607	4822 130 60511	BC847B
3520	4822 051 30103	10k 5% 0.062W	3679	4822 051 30008	0Ω jumper	7608	4822 130 60373	BC856B
3521	4822 051 30103	10k 5% 0.062W	3681	4822 051 30008	0Ω jumper	7609	4822 130 60373	BC856B
3522	4822 051 30103	10k 5% 0.062W	3683	4822 051 30008	0Ω jumper	7610	4822 130 60511	BC847B
3523	4822 051 30332	3k3 5% 0.062W	3685	4822 051 30008	0Ω jumper	7611	9352 456 80115	
3524	4822 051 30101	100Ω 5% 0.062W	3686	4822 051 30223	22k 5% 0.062W	7612	4822 130 60511	BC847B
3525	4822 051 30103	10k 5% 0.062W	3687	4822 051 30223	22k 5% 0.062W	7613	4822 130 60511	BC847B
3526	4822 051 30103	10k 5% 0.062W	3688	4822 051 30472	4k7 5% 0.062W	7614	4822 130 60511	BC847B
3528	4822 051 30103	10k 5% 0.062W	3689	4822 051 30223	22k 5% 0.062W	7614	4822 130 60511	BC847B
3534	4822 051 30103	10k 5% 0.062W	3692	4822 051 30103	10k 5% 0.062W	7615	4822 130 60511	BC847B
3535	4822 051 30153	15k 5% 0.062W	3693	4822 117 12925	47k 1% 0.063W 0603	7616	9322 151 71668	IC SM MK2703STR (MICL) R
3536	4822 051 30101	100Ω 5% 0.062W	3694	4822 117 13632	100k 1% 0603 0.62W	7617	4822 130 60511	BC847B
3537	4822 051 30331	330Ω 5% 0.062W	3696	4822 051 30472	4k7 5% 0.062W	7618	4822 130 60511	BC847B
3538	4822 051 30681	680Ω 5% 0.062W	3697	4822 117 13632	100k 1% 0603 0.62W	7620	4822 130 60373	BC856B
3541	4822 051 30479	47Ω 5% 0.062W	3698	4822 051 30103	10k 5% 0.062W	7621	4822 130 42804	BC817-25
3542	4822 051 30479	47Ω 5% 0.062W	3699	4822 051 30103	10k 5% 0.062W	7622	4822 130 60511	BC847B
3545	4822 051 30221	220Ω 5% 0.062W	3700	4822 051 30472	4k7 5% 0.062W			
3546	4822 051 30101	100Ω 5% 0.062W						
3548	4822 051 30008	0Ω jumper						
3549	4822 051 30008	0Ω jumper						
3550	4822 051 30101	100Ω 5% 0.062W						
3551	4822 051 30101	100Ω 5% 0.062W						
3552	4822 051 30008	0Ω jumper						
3554	4822 051 30008	0Ω jumper						
3564	4822 051 30008	0Ω jumper						
3566	4822 051 30008	0Ω jumper						
3570	4822 051 30101	100Ω 5% 0.062W						
3571	4822 051 30689	68Ω 5% 0.063W 0603 RC21 RST SM						
3572	4822 051 30689	68Ω 5% 0.063W 0603 RC21 RST SM						
3574	4822 051 30008	0Ω jumper						
3605	4822 051 30008	0Ω jumper						
3606	4822 117 12925	47k 1% 0.063W 0603						
3607	4822 117 13632	100k 1% 0603 0.62W						
3608	4822 117 13632	100k 1% 0603 0.62W						
3609	4822 117 13632	100k 1% 0603 0.62W						
3610	4822 051 30103	10k 5% 0.062W						
3611	4822 051 30103	10k 5% 0.062W						
3612	4822 051 30103	10k 5% 0.062W						
3613	4822 051 30103	10k 5% 0.062W						
3614	4822 051 30103	10k 5% 0.062W						
3615	4822 051 30103	10k 5% 0.062W						
3616	4822 051 30103	10k 5% 0.062W						
3618	4822 051 30223	22k 5% 0.062W						
3619	4822 051 30223	22k 5% 0.062W						
3620	4822 051 30101	100Ω 5% 0.062W						
3621	4822 051 30101	100Ω 5% 0.062W						
3622	4822 051 30101	100Ω 5% 0.062W						
3623	4822 051 30101	100Ω 5% 0.062W						
3624	4822 051 30101	100Ω 5% 0.062W						
3625	4822 051 30101	100Ω 5% 0.062W						
3626	4822 051 30102	1k 5% 0.062W						
3627	4822 051 30471	470Ω 5% 0.062W						
3628	4822 051 30471	470Ω 5% 0.062W						
3629	4822 051 30472	4k7 5% 0.062W						
3630	4822 051 30221	220Ω 5% 0.062W						
3631	2322 704 64301	RST SM 0603 RC22H 430Ω PM1 R						
3632	2322 704 64301	RST SM 0603 RC22H 430Ω PM1 R						
3633	2322 704 64301	RST SM 0603 RC22H 430Ω PM1 R						
3635	4822 051 30682	6k8 5% 0.062W						
3636	4822 051 30682	6k8 5% 0.062W						
3637	4822 051 30332	3k3 5% 0.062W						
3642	4822 051 30103	10k 5% 0.062W						
3647	2322 704 64301	RST SM 0603 RC22H 430Ω PM1 R						
3648	2322 704 64301	RST SM 0603 RC22H 430Ω PM1 R						
3651	2322 704 64301	RST SM 0603 RC22H 430Ω PM1 R						
3654	2322 704 64301	RST SM 0603 RC22H 430Ω PM1 R						
3655	2322 704 64301	RST SM 0603 RC22H 430Ω PM1 R						
3656	2322 704 64301	RST SM 0603 RC22H 430Ω PM1 R						
5200	4822 157 11717	BLM31P500SPT	5300	4822 157 11717	BLM31P500SPT			
5301	4822 157 11717	BLM31P500SPT	5402	4822 157 11499	BLM11P600SPT			
5403	4822 157 11499	BLM11P600SPT	5501	4822 157 70299	2.2μH (NL322522T-2R2J)			
5502	4822 157 70299	2.2μH (NL322522T-2R2J)	5503	4822 157 71206	BLM21A601SPT			
5504	4822 157 71206	BLM21A601SPT	5600	4822 157 71206	BLM21A601SPT			
5601	4822 157 11499	BLM11P600SPT	5602	4822 157 70298	15μH (NL322522T-150J)			
5602	4822 157 70298	15μH (NL322522T-150J)	5603	4822 157 71206	BLM21A601SPT			
5603	4822 157 71206	BLM21A601SPT	5604	4822 157 70298	15μH (NL322522T-150J)			
5604	4822 157 70298	15μH (NL322522T-150J)	5605	4822 157 70298	15μH (NL322522T-150J)			
5605	4822 157 70298	15μH (NL322522T-150J)	5606	4822 157 70298	15μH (NL322522T-150J)			
5606	4822 157 70298	15μH (NL322522T-150J)	5607	4822 157 70298	15μH (NL322522T-150J)			
5608	4822 157 70298	15μH (NL322522T-150J)	5608	4822 157 70298	15μH (NL322522T-150J)			
5609	4822 157 11717	BLM31P500SPT	5609	4822 157 11717	BLM31P500SPT			
5610	4822 157 11717	BLM31P500SPT						
6200	4822 130 11397	BAS316						
6301	9322 128 69685	S1D						
6302	9322 128 69685	S1D						
6303	9322 128 69685	S1D						
6600	4822 130 11528	1PS76SB10						
7100	5322 130 42718	BFS20						
7101	5322 130 42718	BFS20						
7102	9352 637 37518	TZA1033HL						
7103	4822 209 17229	BA5938FM						
7104	4822 209 30095	LM833D						
7105	4822 209 32073	MC34072D						
7106	5322 130 42718	BFS20						
7109	4822 209 15083	AN78M09						
7110	5322 130 60803	BST72A						
7111	4822 130 60511	BC847B						
7112	4822 130 60511	BC847B						
7113	4822 130 60511	BC847B						
7114	4822 130 60511	BC847B						

0382	3111 170 21992	SCART CABLE (L=1.10M) BMS
0384	3139 228 87051	PROD.ASSY RC19133001/ 01 PACKED
0387	3139 246 10711	IFU DVD612/05X
1002	3139 248 80861	PCBAS AV DVD612 EU
1003	3139 248 80941	PCBAS FR DVD612 EU
1005	3122 427 22572	PSU DVD VFM EURO
1014	3104 157 11190	CWAS FLEX DVD 22 130 32S

RTV servis Horvat**Tel: ++385-31-856-637****Tel/fax: ++385-31-856-139****Mob: 098-788-319****www.rtv-horvat-dj.hr**